

SFF Committee documentation may be purchased (see 1.4).
SFF Committee documents are available by FaxAccess at 408-741-1600

SFF Committee
Information Specification for
ATA Packet Interface for CD-ROMs

Rev 2.6 January 22, 1996

This specification describes the ATA Packet Interface for CD-ROMs.

Any questions should be addressed to Tom Hanan.

Information Specifications are not developed or endorsed by the SFF Committee but were submitted for distribution on the basis that they are of interest to the storage industry. If the members agree, then the document is distributed by the SFF. The copyright on the contents remains with the contributor.

Contributors are not required to abide by the SFF patent policy. Readers are advised of the possibility that there may be patent issues associated with an implementation which relies upon the contents of an 'i' specification.

SFF accepts no responsibility for the validity of the contents.

Tom Hanan
Western Digital
8105 Irvine Center Dr
Irvine
CA 92718

949-932-7472
949-932-7312Fx
hanan_t@dt.wdc.com

I. Dal Allan
Chair SFF Committee
ENDL
1446 Black Walnut Ct
Saratoga
CA 95070
408-867-6630
408-867-2115Fx
250-1752@mcimail.com

Small Form Factor Committee Specification of

Revision 2.6 Proposed
January 22, 1996
Status: Review Copy

ATA Packet Interface for CD-ROMs SFF-8020i

Member Companies Supporting This Specification:

Member Companies Voting Against This Specification:

Point of Contact: I. Dal Allan
Chairman SFF Committee
ENDL
14426 Black Walnut Court
Saratoga, CA 95070
Ph: (408) 867-6630
Fax: (408) 867-2115
E-Mail: 250-1752@mcimail.com

SFF Fax Access: (408) 741-1600

Technical Editors: Tom Hanan
Western Digital Corporation
8105 Irvine Center Drive
Irvine Calif. 92718
Ph: (714) 932-7472
Fax: (714) 932-7312
E-Mail: hanan_t@al.wdc.com

Devon Worrell
Western Digital Corporation
8105 Irvine Center Drive
Irvine Calif 92718
Ph: (714) 932-7042
Fax: (714) 932-7796
E-Mail: worrell@dt.wdc.com

The following member companies of the SFF Committee voted in favor of this industry specification.

3M
AMP
Aztech Systems
Berg
Cirrus Logic
Compaq
DEC
Dell
ENDL
Fujitsu Microelectronics
Hitachi America
Honda Connector
IBM
Integral Peripherals
Intel
Madison Cable
Methode
Microsoft
Mitsumi
Molex
National Semiconductor
NEC Electronics
Oak Technology
Philips LMS
Robinson Nugent
Sanyo
Sigmax
Sony
Sun Microsystems
Wearnes Peripherals
Western Digital

The following member companies of the SFF Committee voted against this industry specification.

Adaptec
Conner Peripherals
Maxtor
Quantum
Silicon Systems

The following member companies of the SFF Committee voted to forward this industry specification to an accredited standards body.

Adaptec
Cirrus Logic
Dell
ENDL
Fujitsu Microelectronics
Maxtor
Methode
National Semiconductor
Oak Technology
Quantum
Robinson Nugent
Silicon Systems
Wearnes Peripherals

Table of Contents

1.0 Introduction 1

1.1 Abstract. 1

1.2 Secretariat 1

1.3 Summary of SFF Principals 2

1.4 SFF Membership and Fees 3

1.5 Scope 4

1.6 Audience 4

1.7 Normative References 4

1.8 Prerequisites and Related Documents 5

1.9 Layout of the Document 5

1.10 Patents 6

1.11 Unresolved Issues 6

1.12 Change History 6

2.0 General. 9

2.1 Overview 9

2.2 Feature Summary. 9

3.0 Conventions 11

3.1 Document Conventions 11

3.2 Signal Conventions. 11

3.3 Definitions 11

3.3.1 Absolute F Field 11

3.3.2 Absolute M Field 11

3.3.3 Absolute S Field 11

3.3.4 ATA (AT Attachment) 12

3.3.5 BCD 12

3.3.6 Block 12

3.3.7 Blocks Per Sector. 12

3.3.8 CD-DA 12

3.3.9 CD-ROM 12

3.3.10 CD-ROM Control Field 12

3.3.11 CD-ROM Data Mode. 12

3.3.12 Changer 12

3.3.13 CHS (Cylinder-Head-Sector). 13

3.3.14 CIRC 13

3.3.15 Command Packet (CP) 13

3.3.16 Data Block 13

3.3.17 DMA (Direct Memory Access). 13

3.3.18 Field 13

3.3.19 Frame 13

3.3.20 Hold Track State 13

3.3.21 Index 13

3.3.22 Invalid 13

3.3.23 LBA (Logical Block Address) 14

3.3.24 Logical Block. 14

3.3.25 Lead-in Area 14

3.3.26 Lead-out Area 14

3.3.27 L-EC 14

3.3.28 LUN 14

3.3.29 Mandatory 14

3.3.30 MSF Address 14

3.3.31 One 14

3.3.32 Optional. 14

Table of Contents

	3.3.33	Output Port	15
	3.3.34	Page	15
	3.3.35	Pause Area	15
	3.3.36	PIO (Programmed Input/Output)	15
	3.3.37	Post-gap Area	15
	3.3.38	Pre-gap Area	15
	3.3.39	Relative F Field	15
	3.3.40	Relative M Field	15
	3.3.41	Relative S Field	15
	3.3.42	SAM	15
	3.3.43	Reserved	15
	3.3.44	Sector	16
	3.3.45	Status	16
	3.3.46	Sub-channel	16
	3.3.47	TOC	16
	3.3.48	Track	16
	3.3.49	Transition Area	16
	3.3.50	VU (Vendor Unique)	16
	3.3.51	Zero	16
	3.4	Symbols and Abbreviations	16
4.0		ATAPI Overview	17
	4.1	ATA Signal Utilization	17
	4.2	ATA Command Utilization	17
	4.3	ATA Compatibility	17
	4.4	Packet Types	17
	4.5	How SCSI is Used by ATAPI	19
	4.5.1	Differences from the SCSI Standard	19
	4.5.2	Redundant Command Functionality (Task File vs. Packet)	20
	4.5.2.1	Door Lock and Door Unlock vs. Prevent / Allow Medium Removal	20
	4.5.2.2	ATAPI Identify Drive vs. Inquiry	20
	4.5.2.3	Initialize Drive Parameters and Set Features vs. Mode Sense and Mode Select 20	
5.0		ATAPI Protocol	21
	5.1	Initialization	21
	5.2	ATAPI PACKET Command	21
	5.3	Status Register Utilization for Packet Commands	22
	5.4	Byte Count Register (Cylinder Low/High) Usage for Packet Commands	22
	5.5	Sector Count (ATAPI Interrupt Reason) Register Usage for Packet Commands	23
	5.6	Immediate Command Operation	23
	5.7	Overlapped Operation	24
	5.7.1	Example of ATAPI Overlap with only one ATAPI Peripheral	24
	5.8	Flow of Packet Command, PIO Data In to Host	25
	5.9	Flow of Overlapped Commands with Data Transfer In to Host	27
	5.10	Flow of Packet Command with PIO Data Out from the Host	30
	5.11	Flow of Overlapped Commands with Data Transfer Out From Host	32
	5.12	Flow of Non-Overlap DMA Data Commands	35
	5.13	Flow of Non-data Commands	35
	5.14	Timing of Non-Overlap Packet Command	36
	5.15	Timing of Non-Overlap Data and Status Transfer	37
	5.16	Control Signal Timing Requirements and Relationships	38
	5.17	Overlapped Command Operation	39
	5.17.1	Release	40
	5.17.2	Service Command (A2h)	40

Table of Contents

	5.17.3	Overlapped Operation, Legal Transitions	42
	5.17.4	Task File ownership	45
	5.17.5	Error Handling with Overlapped Commands	45
5.18		BIOS and ATAPI Driver Compatibility	46
	5.18.1	Reset Master/Slave Diagnostics Sequence	46
	5.18.2	SRST Initialization Sequence	46
	5.18.2.1	SRST Sequence Device 0	46
	5.18.2.2	SRST Sequence Device 1	46
	5.18.2.3	Other SRST Related Issues	47
	5.18.3	Special Handling of ATA Read and Identify Drive Commands	47
	5.18.4	ATAPI aware BIOS and Driver Considerations	47
	5.18.5	Default Timing	48
6.0		ATAPI Transport Mechanism	49
	6.1	Reset Conditions	49
	6.1.1	Power On or Hardware Reset.	49
	6.2	ATAPI Soft Reset Command and Protocol	50
	6.3	ATAPI Implementation of ATA SRST	50
	6.4	Physical Connection	52
	6.5	Single Drive Configurations	52
	6.6	Register Mapping	54
	6.7	ATAPI Register Map (Packet Command)	54
7.0		CD-ROM ATA (Task File) Commands	59
	7.1	ATA (Task File) Command Implementation Requirements	59
	7.1.1	ATAPI Soft Reset	60
	7.1.2	Check Power Mode.	60
	7.1.3	Execute Drive Diagnostics	60
	7.1.4	Idle Immediate	61
	7.1.5	NOP.	61
	7.1.6	Packet Command	62
	7.1.7	ATAPI Identify Device.	62
	7.1.7.1	General Configuration Word (0)	63
	7.1.7.2	Serial Number (Words 10 - 19).	64
	7.1.7.3	Firmware Revision (Words 23-26).	64
	7.1.7.4	Model Number (Words 27 - 46)	64
	7.1.7.5	Capabilities Word (Word 49).	65
	7.1.7.6	PIO Data Transfer Cycle Timing (Word 51).	65
	7.1.7.7	DMA Data Transfer Cycle Timing (Word 52).	65
	7.1.7.8	Field Validity (Word 53)	65
	7.1.7.9	Single Word DMA Transfer (Word 62)	66
	7.1.7.10	Multi Word DMA Transfer (Word 63).	66
	7.1.7.11	Enhanced PIO Mode (Word 64)	66
	7.1.7.12	Minimum Multi-word DMA Transfer Cycle Time per Word (Word 65)	66
	7.1.7.13	Manufacturer's Recommended Multi-word DMA Cycle Time (Word 66)	66
	7.1.7.14	Minimum PIO Transfer Cycle Time Without Flow Control (Word 67)	66
	7.1.7.15	Minimum PIO Transfer Cycle Time with IORDY Flow Control (Word 68)	67
	7.1.7.16	Typical Time for the Release After Command Received (Word 71)	67
	7.1.7.17	Typical Time for the Clearing of Busy After SERVICE Command (Word 72)	67
	7.1.7.18	Major Version Number (Word 73)	67
	7.1.7.19	Minor Version Number (Word 74).	67
	7.1.8	Service	68
	7.1.9	Set Features.	68
	7.1.9.1	Set Transfer Mode (03h)	69

Table of Contents

	7.1.9.2	Enable Interrupt for Release after receipt of Command Packet (5Dh)	69
	7.1.9.3	Enable Interrupt After Completion of Service Command (5Eh)	69
	7.1.9.4	Disable Reverting to Power On Defaults (66h)	70
	7.1.9.5	Enable Reverting to Power On Defaults (CCh)	70
	7.1.9.6	Disable Interrupt for Release after receipt of Command Packet (DDh)	70
	7.1.9.7	Disable Interrupt After Completion of Service Command (DEh)	70
	7.1.10	Sleep	70
	7.1.11	Standby Immediate	70
8.0		CD-ROM Model	71
	8.1	New Capabilities Since the SCSI-2 Standardization	71
	8.2	CD-ROM Media Organization	71
	8.3	CD-ROM Physical Data Format	75
	8.3.1	Frame Format for Audio	75
	8.3.2	Sector Format for Data	75
	8.3.3	Sub-channel Information Formats	76
	8.4	CD Audio Error Reporting	77
	8.5	CD-ROM Ready Condition/Not Ready Condition	77
	8.5.1	Packet Command Not Ready Status Utilization	78
	8.6	CD-ROM Address Reporting Formats (MSF bit)	78
	8.7	Error Reporting	79
9.0		Changer Model	81
	9.1	Initialization	82
	9.2	Changer Addressing	83
	9.3	Automatic Load and Unload Operations	83
	9.4	Delayed Disc load operation	83
	9.5	Prevent / Allow processing	84
	9.6	Error Reporting	84
10.0		CD-ROM Packet Commands	87
	10.1	Packet Command Implementation Requirements	87
	10.1.1	Reserved	87
	10.1.2	Operation Code Types	87
	10.2	ATAPI Command Packet Description	88
	10.2.1	Operation Code	89
	10.2.2	Logical Block Address	89
	10.2.3	Transfer Length	89
	10.2.4	Parameter List Length	89
	10.2.5	Allocation Length	89
	10.3	Status	89
	10.4	Immediate Command Processing Considerations	90
	10.5	Command Processing Considerations and Exception Conditions	90
	10.5.1	Parameter Rounding	90
	10.6	Unit Attention Condition	90
	10.7	Commands and Parameters	91
	10.8	ATAPI Packet Commands for CD-ROM Devices	92
	10.8.1	INQUIRY Command	93
	10.8.1.1	Standard INQUIRY Data	93
	10.8.1.2	Using the INQUIRY Command	94
	10.8.2	LOAD/UNLOAD CD Command	97
	10.8.3	MECHANISM STATUS Command	99
	10.8.4	MODE SELECT Command	103
	10.8.5	MODE SENSE Command	105
	10.8.5.1	Current Values	106

Table of Contents

10.8.5.2	Changeable Values106
10.8.5.3	Default Values106
10.8.5.4	Saved Values106
10.8.5.5	Initial Responses106
10.8.6	Mode Select/Sense Parameters108
10.8.6.1	CD-ROM Audio Control Parameters Page111
10.8.6.2	CD-ROM Device Parameters Page113
10.8.6.3	Read Error Recovery Parameters Page114
10.8.6.4	CD-ROM Capabilities and Mechanical Status Page118
10.8.7	PAUSE/RESUME Command123
10.8.8	PLAY AUDIO Command125
10.8.8.1	Play Audio with Immediate Packet Commands126
10.8.9	PLAY AUDIO MSF Command128
10.8.10	PLAY CD Command131
10.8.11	PREVENT/ALLOW MEDIUM REMOVAL Command135
10.8.12	READ (10) Command137
10.8.13	READ (12) Command139
10.8.14	READ CD-ROM CAPACITY Command141
10.8.15	READ CD Command143
10.8.15.1	Description of Sub-channels R-W151
10.8.16	READ CD MSF Command155
10.8.17	READ HEADER Command157
10.8.18	READ SUB-CHANNEL Command161
10.8.18.1	CD-ROM Current Position Data Format162
10.8.18.2	Media Catalogue Number Data Format165
10.8.18.3	Track International Standard Recording Code Data Format166
10.8.18.4	Caching of Sub-Channel Data168
10.8.19	READ TOC Command169
10.8.19.1	Sub-channel Q TOC information175
10.8.19.2	Example Read TOC Operations177
10.8.20	REQUEST SENSE Command179
10.8.20.1	Sense-key Specific181
10.8.20.2	Deferred Errors182
10.8.20.3	Sense-key and Sense Code Definitions183
10.8.20.4	Using the REQUEST SENSE Command183
10.8.21	SCAN Command187
10.8.22	SEEK Command191
10.8.23	SET CD SPEED Command193
10.8.24	STOP PLAY / SCAN CD-ROM Command195
10.8.25	START/STOP UNIT Command197
10.8.26	TEST UNIT READY Command199
10.8.26.1	Using the TEST UNIT READY Command199
11.0	Physical Interface201
11.1	CD-ROM Digital Audio Connector (Optional)201
11.2	CD-ROM Analog Audio Connector (Optional)201
11.3	Device Configuration Jumper (Optional)202
11.4	Host IDE Interface Connector202
11.5	Power Connector202
Annex A	Play CD Decoder Types & Formats203
Annex B	Connectors205

Intentionally Left Blank

List of Tables

Table 1 - Layout of the Document 5

Table 2 - Generic Command and Status Usage for ATAPI Devices 18

Table 3 - Byte Count Register Usage 23

Table 4 - Registers after the Service Command 41

Table 5 - Legal Transitions for Overlapped Operation 42

Table 6 - Registers Controlled by BSY & DRQ 45

Table 7 - Preferred Drive Connection 52

Table 8 - Shadow Registers 52

Table 9 - Shadowing for Single Drive Configurations 53

Table 10 - I/O Port Functions/Selection Addresses (Compatibility Model) 54

Table 11 - ATAPI Status Register (ATA Status Register) 55

Table 12 - ATAPI Error Register (ATA Error Register) 55

Table 13 - ATAPI Feature Register (ATA Feature Register) 56

Table 14 - ATAPI Byte Count Register (ATA Cylinder High/Low Register) 56

Table 15 - ATAPI Interrupt Reason Register (ATA Sector Count Register) 57

Table 16 - ATAPI Drive Select Register (ATA Drive / Head Select Register) 57

Table 17 - ATAPI Device Control Register (ATA Device Control Register) 57

Table 18 - ATA Command and Status Usage for ATAPI CD-ROM Devices 59

Table 19 - Identify Drive, Fields Supported by CD-ROM 62

Table 20 - Identify Drive Data - General Configuration (Word 0) 63

Table 21 - Identify Drive Data - Capabilities Word (49) 65

Table 22 - Contents of the Feature Register for Set Features Command 68

Table 23 - Set Feature Register Definitions 68

Table 24 - Feature Number Description for Set Feature Command 69

Table 25 - Example Mixed Mode CD-ROM Disc Layout 72

Table 26 - Not Ready Error Reporting (by Command) 78

Table 27 - MSF Address Format 78

Table 28 - Error Conditions and Sense Keys 79

Table 29 - Commands that may cause delayed loads to occur 83

Table 30 - Commands that will cause delayed loads to occur 84

Table 31 - Commands that should not cause delayed loads to occur 84

Table 32 - Error Conditions and Sense Keys for Changer Mechanisms 84

Table 33 - Operation Code Types 87

Table 34 - Typical Command Packet for Most Commands 88

Table 35 - Typical Command Packet for Some Extended Commands 88

Table 36 - Operation Code 89

Table 37 - Packet Commands Supported by CD-ROM Drives 92

Table 38 - INQUIRY Command 93

Table 39 - INQUIRY Data Format 94

Table 40 - Peripheral Device Types 94

Table 41 - Recommended Sense Key, ASC and ASCQ for Inquiry Command Errors 95

Table 42 - Load / Unload Command 97

Table 43 - Load/Unload or Optional Selection Operations 97

Table 44 - recommended Sense Key, ASC and ASCQ for Load / Unload CD 98

Table 45 - MECHANISM STATUS Command 99

Table 46 - Mechanism Status Parameter List 100

Table 47 - Mechanism Status Header 100

Table 48 - Slot Table Response format 101

Table 49 - Recommended Sense Key, ASC and ASCQ for Mechanism Status 102

Table 50 - Mode Select Command 103

Table 51 - Recommended Sense Key, ASC and ASCQ for Mode Select Command Errors 104

Table 52 - Mode Sense command 105

List of Tables

Table 53 -	Page Control Field105
Table 54 -	Recommended Sense Key, ASC and ASCQ for Mode Sense Command Errors107
Table 55 -	Mode Parameter List108
Table 56 -	Mode Page Codes for CD-ROM108
Table 57 -	Mode Page Format108
Table 58 -	Mode Parameter Header109
Table 59 -	CD-ROM Media Type Codes109
Table 60 -	CD-ROM Audio Control Mode Page Format111
Table 61 -	CDDA Output Port Channel Selection Codes112
Table 62 -	Attenuation Levels for Audio112
Table 63 -	CD-ROM Parameters Page Format113
Table 64 -	Inactivity Time Multiplier Values113
Table 65 -	Read Error Recovery Parameters Page Format114
Table 66 -	Error Recovery Bit Settings115
Table 67 -	CD-ROM Error Recovery Descriptions115
Table 68 -	CD-ROM Capabilities and Mechanical Status Page Format118
Table 69 -	Example Data Rates121
Table 70 -	PAUSE/RESUME Command123
Table 71 -	Recommended Sense Key, ASC and ASCQ for Pause/Resume Command Errors123
Table 72 -	PLAY AUDIO Command125
Table 73 -	Recommended Sense Key, ASC and ASCQ for Play Audio Command Errors126
Table 74 -	Commands That Will Stop a Play or Scan Operation127
Table 75 -	Commands That Will Not Stop a Play or Scan Operation127
Table 76 -	PLAY AUDIO MSF Command128
Table 77 -	Recommended Sense Key, ASC and ASCQ for Play Audio MSF Command Errors129
Table 78 -	PLAY CD Command (LBA Form)131
Table 79 -	PLAY CD Command (MSF Form)131
Table 80 -	PLAY CD, Expected Sector Type Field Definition132
Table 81 -	PLAY CD, Field Definition132
Table 82 -	Recommended Sense Key, ASC and ASCQ for PLAY CD Command Errors133
Table 83 -	PREVENT ALLOW MEDIUM REMOVAL Command135
Table 84 -	Actions for Lock / Unlock / Eject136
Table 85 -	Recommended Sense Key, ASC and ASCQ for Prevent/Allow Command Errors136
Table 86 -	READ (10) Command137
Table 87 -	Recommended Sense Key, ASC and ASCQ for READ (10) Command Errors138
Table 88 -	READ (12) Command139
Table 89 -	Recommended Sense Key, ASC and ASCQ for READ (10) Command Errors140
Table 90 -	READ CD-ROM CAPACITY Command141
Table 91 -	READ CAPACITY DATA141
Table 92 -	Recommended Sense Key, ASC and ASCQ for Read Capacity Command Errors142
Table 93 -	READ CD Command143
Table 94 -	READ-CD, Expected Sector Type Field Definition144
Table 95 -	READ CD, Header(s) Code Field Definition144
Table 96 -	READ CD, Error Flag(s) Field Definition145
Table 97 -	READ CD, Sub-channel Data Selection Field Definition145
Table 98 -	Formatted Q-subcode Data (A Total of 16 Bytes)146
Table 99 -	Number of Bytes Returned Based on Data Selection Field147
Table 100 -	Recommended Sense Key, ASC and ASCQ for Read CD Command Errors148
Table 101 -	CD-DA (Digital Audio) Data Block Format149
Table 102 -	R-W Raw152
Table 103 -	R-W De-Interleaved & Error Corrected152
Table 104 -	Sub-channel R-W, Allowed Mode/Item Combinations153

List of Tables

Table 105 - READ CD MSF Command155

Table 106 - Recommended Sense Key, ASC and ASCQ for Read CD MSF Command Errors.156

Table 107 - READ HEADER Command157

Table 108 - READ HEADER LBA Data Format157

Table 109 - READ HEADER MSF Data Format158

Table 110 - CD-ROM Data Mode Codes158

Table 111 - Recommended Sense Key, ASC and ASCQ for Read Header Command Errors.159

Table 113 - Sub-channel Data Header Format161

Table 112 - READ SUB-CHANNEL Command161

Table 114 - Sub-channel Data Format Codes162

Table 115 - CD-ROM Current Position Data Format (Format Code 01h).162

Table 116 - Audio Status Codes163

Table 117 - ADR Sub-channel Q Field163

Table 118 - Sub-channel Q Control Bits164

Table 119 - Media Catalogue Number Data Format (Format Code 02h)165

Table 120 - UPC Format166

Table 121 - Track International Standard Recording Code Data Format166

Table 122 - Raw ISRC Format on the CD-ROM Disc.167

Table 123 - ISRC Format of Data Returned to Host.167

Table 124 - Recommended Sense Key, ASC and ASCQ for Read Sub-channel Command Errors.168

Table 125 - READ TOC Command169

Table 126 - Read TOC Data Format (With Format Field = 00b)170

Table 127 - Read TOC Data Format (With Format Field = 01b)171

Table 128 - Read TOC Data Format (With Format Field = 10b)172

Table 129 - TOC Track Descriptors173

Table 130 - Recommended Sense Key, ASC and ASCQ for Read TOC Command Errors.174

Table 131 - Lead in Area (TOC), Sub-channel Q formats175

Table 132 - Bit Definitions for the Control Field in Sub-channel Q.176

Table 133 - Values for Control Field in Sub-channel Q176

Table 134 - Example Read TOC Operations.177

Table 135 - Values for Control Field in Read TOC178

Table 136 - Request Sense Command179

Table 137 - Request Sense Standard Data180

Table 138 - Field Pointer Bytes181

Table 139 - Field Pointer Bytes182

Table 140 - Sense Key Descriptions183

Table 141 - ASC and ASCQ Assignments.184

Table 142 - Recommended Sense Key, ASC and ASCQ for Request Sense Command Errors.185

Table 143 - SCAN Command187

Table 144 - Scan Starting Address in Logical Block Format188

Table 145 - Scan Starting Address in AMIN, ASEC and AFRAME Format188

Table 146 - Scan Starting Address in Track Number (TNO) Format188

Table 147 - Recommended Sense Key, ASC and ASCQ for Scan Command Errors189

Table 148 - SEEK Command191

Table 149 - Recommended Sense Key, ASC and ASCQ for Seek Command Errors191

Table 150 - SET CD-ROM SPEED Command193

Table 151 - Recommended Sense Key, ASC and ASCQ for SET CD SPEED Command Errors193

Table 152 - STOP PLAY / SCAN CD-ROM Command195

Table 153 - Recommended Sense Key, ASC and ASCQ for STOP PLAY CD-ROM Command Errors.195

Table 154 - START/STOP UNIT Command197

Table 155 - Start/Stop and Eject Operations197

Table 156 - Actions for Eject/Load Disc.198

Table 157 - Recommended Sense Key, ASC and ASCQ for SEEK Command Errors198
Table 158 - Test Unit Ready Command199
Table 159 - Recommended Sense Key, ASC and ASCQ for MODE SELECT Command Errors200

List of Figures

Figure 1 - Example ATAPI Overlap Command Sequence 24
Figure 2 - Packet Command with PIO Data In to Host. 26
Figure 3 - Overlapped Packet Command with PIO Data In to Host 29
Figure 4 - Packet Command with PIO Data Out from Host 31
Figure 5 - Overlapped Packet Command with PIO Data Out From Host 34
Figure 6 - Timing of Command Packet Transfer. 36
Figure 7 - Timing of Data and Status Transfer. 37
Figure 8 - State Diagram, Overlapped Operation 43
Figure 9 - ATAPI Overlap, One ATA Device and One ATAPI Device 44
Figure 10 - DASP / PDIAG Sequence after Hardware Reset or Power On 50
Figure 11 - CD-ROM Sector Formats 73
Figure 12 - Changer State Diagram 82
Figure 13 - Read CD Data Stream Order150
Figure 14 - Read CD Sub-channel, R-W (100b).151
Figure 15 - Stop Play/Play Audio/Audio Scan/Pause/Resume Sequencing196
Figure 16 - Test Unit Ready State Diagram200
Figure 17 - CD-ROM Connectors (Rear View)201
Figure 18 - Device Configuration Jumper202

Intentionally Left Blank

1.0 Introduction

The ATA/IDE interface has become a de facto industry standard for connection of disk drives in PC's. In the interest of simplicity and cost, the ATA/IDE interface was originally designed to support only a small subset of computer peripherals. The expanding use of multimedia, inexpensive program distribution on CD ROM, and faster and more powerful systems has created the need for enhancements to ATA. This specification is one of those enhancements and provides a simple and inexpensive CD-ROM interface through a superset of ATA.

1.1 Abstract

This document defines a standard method for interfacing to a CD-ROM Drive utilizing the existing ATA host computer hardware and cabling. This specification supplements the definitions of an ATA mass storage peripheral found in the ATA document. The ATAPI and CD-ROM interfaces described in this document are compatible with existing ATA hardware without any changes or additional pins.

1.2 Secretariat

The SFF Committee is an ad hoc group formed to address disk industry needs in a prompt manner. When formed in 1990, the original goals were limited to defining de facto mechanical envelopes for disk drives so they could fit into laptop computers and other small products.

In November 1992, the SFF Committee objectives were broadened to encompass areas other than mechanical form factors for drives, which needed prompt industry action. SFF Specifications are narrow in scope, to reduce development time.

The SFF Committee complements the formal standards process. Some industry needs cannot be addressed by standards because of timing, or charter, or some other consideration. This is a gap the Small Form Factor Committee fills.

It is anticipated that most Specifications will be Forwarded to an accredited standards body such as EIA (Electronic Industries Association) or ASC (Accredited Standards Committee) X3T10. They may be accepted for separate standards, or incorporated into other standards activities.

The members decision to forward is based on a wide variety of factors, and a document can be forwarded at any stage in its development cycle. For example, if a proposal is under development within SFF, and a standards project begins in a similar area. The SFF members might submit the draft of the SFF Specification to the standards committee rather than operate a parallel effort.

In the case of proposals submitted to SFF which now have a status of Fs, the proposal never became an SFF project or specification. Instead the proposal was forwarded to the appropriate standards body for further consideration. A copy of the proposal submitted to SFF remains available for historical purposes, however, the contents may no longer be valid. The latest documentation for forwarded SFF specifications should be obtained from the committee the proposal was forwarded to. The best way to track standards activity is to subscribe to the document service for X3T10 subcommittees:

CBEMA X3 Secretariat:	Ph: 202-737-8888
1250 Eye St. #200	Fax: 202-638-4922
Washington DC 20005	

Copies of SFF Specifications are available by FaxAccess or by joining the SFF Committee as an Observer (\$300 or \$400 overseas) or Member (\$3,000).

14426 Black Walnut Ct	Ph: 408-867-6630x303	Email: 250-1752@mcimail.com
Saratoga CA 95070	Fax: 408-867-2115	FaxAccess: 408-741-1600

1.3 Summary of SFF Principals

Documents created by the SFF Committee are expected to be submitted to accredited standards bodies such as EIA (Electronic Industries Association) or ASC (Accredited Standards Committee) X3T10. They may be accepted for separate standards, or incorporated into other standards activities. The principles of operation for the SFF Committee are not unlike those of an accredited standards committee. There are 3 levels of participation:

- Attending the meetings is open to all, but taking part in discussions is limited to member companies, or those invited by member companies.
- The minutes and copies of material which are discussed during meetings are distributed only to those who sign up to receive documentation.
- The individuals who represent member companies of the SFF Committee receive documentation and vote on issues that arise. Votes are not taken during meetings, only guidance on directions. All voting is by letter ballot, which ensures all members an equal opportunity to be heard.

Material presented at SFF Committee meetings becomes public domain. There are no restrictions on the open mailing of material presented at committee meetings. In order to reduce disagreements and misunderstandings, copies must be provided for all agenda items that are discussed. Copies of the material presented, or revisions if completed in time, are included in the documentation mailings.

The sites for SFF Committee meetings rotate based on which member companies volunteer to host the meetings. For information on meeting dates and places, subscribe to the SFF E-mail reflector.

1.5 Scope

This document is intended to be used with the ATA document. Its purpose is to highlight those areas of implementation in which the CD-ROM Interface and the ATA document differ. In addition, it indicates areas within the ATA document which are modified for operation in the CD-ROM environment. Both mandatory and optional specifications are presented.

In the event of a conflict between one of the base documents (ATA / SCSI CD-ROM) and this document, the interpretation of this document *shall prevail only if this document acknowledges that a conflict exists between the documents*.

This document provides a description for the ATAPI Transport Protocol (TP), ATAPI Transport Mechanism (TM) as well as a CD-ROM Command Protocol (CP).

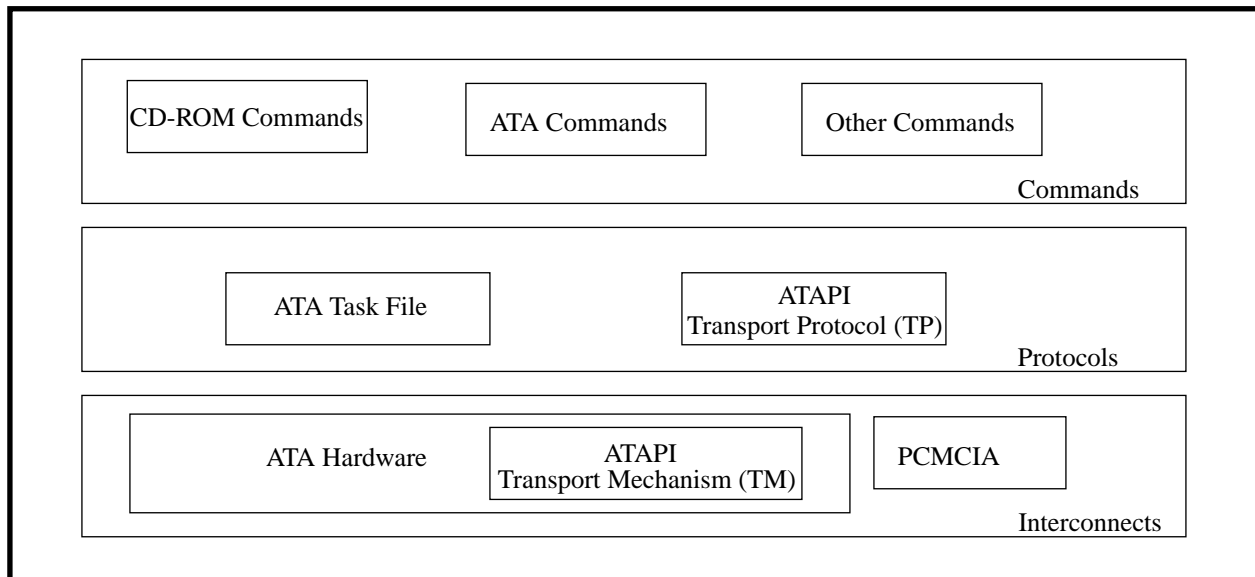

1.6 Audience

This document is intended for use by Computer System, CD-ROM Peripheral, and CD-ROM chip set vendors.

1.7 Normative References

The following standards contain provisions which, when referenced in the text of this standard, constitute provisions of this Specification. At the time of publication, the editions indicated were valid. All standards are subject to revision, and parties to agreements based on this Specification are encouraged to investigate the possibility of applying the most recent editions of the standards indicated below. Members of IEC and ISO maintain registers of currently valid International Standards.

ISO/IEC 10149:1989, Information technology - *Data Interchange on Read-only 120 mm Optical Data Disks*.

IEC 908:1987, *Compact Disk Digital Audio System*.

American National Standard Institute X3.131-1994, *Small Computer System Interface*.

American National Standard Institute X3T10/948D *ATA-2 (AT Attachment)*.

1.8 Prerequisites and Related Documents

The reader is expected to have a basic understanding of the AT hardware and software interfaces as well as the ATA Document. Specifically, the following documents are required for understanding and implementing an ATA CD-ROM because this document is based on them:

- CBEMA, ATA (AT Attachment) ANSI Draft Standard, Revision 9482K, December 2, 1994, Document Number X3T10/948, Computer and Business Equipment Manufacturer's Association. This is referred to as the ATA Document.
- ANSI X3T9.2/375R, Small Computer System Interface
- AT bus specification
- Red, Yellow, Green, Orange Books and CD-ROM XA Specification.

1.9 Layout of the Document

This document is broken into several sections:

Table 1 - Layout of the Document

Section "1.0 Introduction" on page 1	Introduction, scope, purpose etc.	SFF-8021
Section "2.0 General" on page 9	Details the current requirements, assumptions and goals.	
Section "3.0 Conventions" on page 11	Describes conventions used in the document, and a definitions of terms and signals.	
Section "4.0 ATAPI Overview" on page 17	Overview of the Packet Interface and how the "Layering" of SCSI and ATA occurs.	SFF-8022
Section "5.0 ATAPI Protocol" on page 21	Describes the actual "Protocol" used for the new Packet Command.	
Section "6.0 ATAPI Transport Mechanism" on page 49	Describes ATAPI register and hardware usage of the ATA Interface.	
section 8.0, "CD-ROM Model", on page 71	Overview and general comments on CD-ROM device functions and media formats.	SFF-8023
section 7.0, "CD-ROM ATA (Task File) Commands", on page 59	ATA Task File Command set definition for the CD-ROM peripheral type.	
Section "10.0 CD-ROM Packet Commands" on page 87	SCSI Command Subset definition for the CD-ROM peripheral type.	SFF-8024
Section "11.0 Physical Interface" on page 201	Describes the physical Host Interface, connectors and their placement.	SFF-8025
Annex "A" Digital Output Annex "B" Connectors	Provides informative reference material which will very likely be implemented by some CD-ROM manufacturers.	SFF-8026 SFF-8027
Annex "C" Errata sheet for SFF-8020 rev 2.x	Identifies current editorial & technical corrections made to SFF-8020 rev 2.x.	SFF-8028

To simplify retrieval of this document via the SFF FaxAccess system, the individual sections of this document are available as individual SFF FaxAccess documents. Unless you have a plain paper fax machine with the ability to print 300 pages in a single fax, you should request the individual sections. Request SFF-8020 to receive the entire document or request any of the numbers between 8021 and 8028 to receive the individual section(s) identified in the table above.

1.10 Patents

The developers of this specification have requested that holders of patents that may be required for the implementation of the specification, disclose such patents to the publisher. However, neither the developers nor the publisher have undertaken a patent search in order to identify which, if any, patents apply to this specification.

No position is taken with respect to the validity of any claim or any patent rights that may have been disclosed. Details of submitted statements may be obtained from the publisher concerning any statement of patents and willingness to grant a license under these rights on reasonable and nondiscriminatory terms and conditions to applicants desiring to obtain such a license.

1.11 Unresolved Issues

This section identifies issues which are still unresolved. Refer to E-mail on the ATAPI Reflector (atapi@dt.wdc.com) for details on each of the issues identified below: Note at this time there are no unresolved issues.

1.12 Change History

SFF 8020 r1.2 was published in February 1994. This has become the defacto industry standard.

After the version 1.2 was published, corrections were made through the use of an errata document. The 8020 and 8029 were used together as a document set. Many changes to 8029 Errata for 8020 r1.2 between March 1994 and March 1995 were made.

1.2 to 2.0 Early 1995.

- All Errata incorporated into the SFF ATAPI Document and 8029 removed from use.

2.0a to 2.1 March 1995.

- Basic Overlap capability added.
- Many editorial changes.

2.1 to 2.2 April 1995.

- Proxy IRQ added.
- Interleaved DMA added.
- CHANGER STATUS, LOAD/UNLOAD CD added. Establishes a simple way for ATAPI tape and CD devices to manage built in low cost CHANGER mechanisms.

2.2 to 2.3 May 1995.

- PLAY CD added. The PLAY CD command simplifies playing audio and video to an external device (e.g. an IEC958 or EBU port).
- Register Shadowing and Single device clarifications were added.
- INQUIRY "Vital Product Data" and "Vital Product Data Parameters" were deleted.
- PLAY AUDIO (12) was deleted.

- Read (12) was deleted.
- PLAY AUDIO TRACK RELATIVE was deleted.
- REZERO UNIT was removed as this command was redundant with the reset command and was unsupported.
- PLAY CD-ROM XA, and SEND CD-ROM XA DATA were removed. The XA Annex and all XA commands (PLAY, SEND) were removed due to a lack of definition and support by OS and ATAPI CD-ROM devices.
- Vendor Identification List (Table 141) was removed since the information is contained in the SCSI document provided as a normative reference.
- READ CD Data Transfer Modes. Many of these modes were deleted because the group felt that they were complicated to implement and not required by current OS drivers.

2.3 to 2.4 July 1995

- MECHANISM STATUS command replaces the Changer Status command. This command become mandatory for both changer and normal CD mechanisms. This command is used by non changer mechanisms to report the current state of the device (includes playing, scanning, idle...).
- Proxy Interrupt removed.
- Overlapped DMA removed.
- Interleaved DMA removed.
- Some clarifications to the Changer commands.
- Many small editorial and clarification changes.

2.4 to 2.5 July 1995

- The Opcode for the MECHANISM STATUS Command has been changed from B8h to BDh.
- The Opcode for the PLAY CD Command has been changed from B4h to BCh.
- The READ (12) has been added back into the specification.
- An ATAPI Version has been added to the INQUIRY Data. For conformance to ATAPI 2.5 the value returned is 2h.
- Further clarifications to the Changer commands were made.
- Sub-channel data returned in the READ CD commands was limited to Audio tracks.
- Table 26 has been rearranged and corrected.
- Mechanism Status, CD Mechanism State information now allows the host to determine if a Play or Read operation is in progress and if the Audio or other ports are in use.
- The SRST will no longer require the drive to perform the DASP / PDIAG Master Slave Handshaking Protocol.
- The Identify Drive Data was brought in line with ATA.

2.5 to 2.6 November 1995

- Clarification of Byte Count Register Usage for Packet Commands.
- Clarification of back-to-back data transfers
- SRST allowed to be used during Power Management of ATAPI Devices

- SRST use of the PDIAG signal is clarified
- Clarification of error condition for truncating data when allocation is non zero.
- Error code returned when loading a slot with no disc present has been changed from 05/24 to 02/3A.
- Table 65, CD-ROM Capabilities and Mechanical Status Page Format, now defines bytes 2 and 3, for new CD media type functions.
- Clarification of CD-ROM Medium Type Codes, Table 56.
- Block Error Flag byte defined as the OR of all C2 Error Bytes.
- Table 120, ISRC Format, byte definitions have been changed.
- Added table for TOC TRACK DESCRIPTORS.
- Section 3.3.49, Track Relative Logical Address, has been removed.
- Bytes 2 and 3 of INQUIRY command changed to "reserved." References to EVPD removed.
- READ TOC command - Format field now includes Byte 2.
- READ TOC Data Format and MSF usage clarified.
- Back-to-back data transfers sequence description added. State diagrams updated.
- SRST PDIAG sequence added.
- Changer functions for delayed load have been clarified.
- Identify Drive Data has been clarified.
- Identify, Additional length information has been clarified.
- Reporting of Errors for Mode Select has been clarified.
- The SSS and SDP bits in the Mode Sense Capabilities Page have been moved.
- Block Length returned for Read CD-ROM Capacity has been clarified.
- Length of data returned for Read TOC commands have been clarified.

2.0 General

2.1 Overview

The primary objective of this Standard is to provide an inexpensive CD-ROM interface. The existing ATA does not provide an adequate command structure to support CD-ROM devices. Although the inclusion of a CD-ROM drive would compromise the performance of another disk on the same ATA Cable, this standard does address this through the use of overlapped operation.

2.2 Feature Summary

This section provides an abbreviated list of the perceived requirements upon which the development of this specification was based.

- **Do not break any existing ATA drive connections when the CD-ROM is attached**, e.g., completely compatible with existing hardware and drivers.
- Prevent BIOS and O/S recognition of ATAPI Peripherals as hard disk drives.
- Allow one ATA cable and I/O registers to support one ATA drive and one CD-ROM peripheral.
- Support for the ATA master / slave protocol.
- Support for 8-bit Task File registers and 16-bit data transfer register.
- Reset the peripheral into a known state.
- Provide a status indication of Peripheral Ready to accept commands.
- Provide capability for sending CDB like (Command Packet Bytes) to the peripheral.
- Support for command packets of at least 12 bytes in length.
- Capability to indicate to the Host computer when Command Packet can be transferred.
- Capability to Interrupt the Host computer when data can be transferred.
- Capability to Interrupt the Host computer when command complete.
- Send & Receive Data bytes using either PIO or DMA.
- Capable of transferring variable length data packets. (Drive indicates to Host amount to transfer.)
- Send Status of command operation (Error / Done / Data Ready...) to the host computer.
- Enable and disable Host interrupts from the peripheral.
- Detect when a peripheral is interrupting (Which & Why.)
- Detect when an ATAPI peripheral is attached to the ATA Cable.
- Support for both primary and secondary ATA addressing / cable.
- Support for all ATA 948 data transfer timing.
- Support for the CD-DA, CD-XA, CD +, Multi Session and Hybrid (Photo CD) formats.
- Support for multiple speed drives.
- Support multiple block sizes (i.e. 2048, 2052, 2056, 2324, 2332, 2336, 2340 & 2352)
- Overlap Commands with non-overlapping ATA devices.
- Support for Embedded Media Changers.

Intentionally Left Blank

3.0 Conventions

3.1 Document Conventions

Certain words and terms used in this document have specific meaning beyond the normal English meaning. These words and terms are defined either in this section or in the text where they first appear. Names of signals, commands, statuses, and sense keys are in all uppercase (e.g. REQUEST SENSE). Lower case is used for words having the normal English meaning.

Fields containing only one bit are usually referred to as the <name> bit instead of the <name> field. Numbers that are not immediately followed by a lower case b or h are decimal (0xnn for Hexadecimal, where nn refers to two hexadecimal digits 0-9, A-F.)

3.2 Signal Conventions

Signal names are shown in all upper case letters. Signals can be asserted (active, true) in either a high (more positive voltage) or low (less positive voltage) state. A dash character (-) at the beginning or end of a signal name indicates it is asserted at the low level (active low). No dash or a plus character (+) at the beginning or end of a signal name indicates it is asserted high (active high). An asserted signal may be driven high or low by an active circuit, or it may be allowed to be pulled to the correct state by the bias circuitry.

Control signals that are asserted for one function when high and asserted for another function when low are named with the asserted high function name followed by a slash character (/), and the asserted low function name followed with a dash (-) e.g. BITENA/BITCLR- enables a bit when high and clears a bit when low. All signals are TTL-compatible unless otherwise noted. "Negated" means that the signal is driven by an active circuit to the state opposite to the asserted state (inactive, or false) or may be simply released (in which case the bias circuitry pulls it inactive, or false) at the option of the implementor.

Control signals that may be used for two mutually exclusive functions are identified with their two names separated by a colon e.g. SPSYNC:CSEL can be used for either the Spindle Sync or the Cable Select functions.

3.3 Definitions

3.3.1 Absolute F Field

Absolute F field is the least significant part of the absolute physical address from the beginning of the media. It is written on CD-ROM media in binary-coded decimal notation. The value ranges from 00 to 74.

3.3.2 Absolute M Field

Absolute M field is the most significant part of the absolute physical address from the beginning of the media. It is written on CD-ROM media in binary-coded decimal notation. The value ranges from 00 to 99.

3.3.3 Absolute S Field

Absolute S field is the intermediate significant part of the absolute physical address from the beginning of the media. It is written on CD-ROM media in binary-coded decimal notation. The value ranges from 00 to 59.

3.3.4 ATA (AT Attachment)

ATA defines a compatible register set and a 40-pin connector and its associated signals.

3.3.5 BCD

Binary coded decimal: The number system used on the physical CD-ROM and CD-DA media. Numbers that use this notation have the 'bcd' suffix attached. A byte has two 4-bit values, each of which can have a value from 0 to 9. The maximum value is 99bcd (99 decimal). BCD is only used on the physical CD Media, and never to/from the host except when raw sub-channel data is returned in the data to the host.

Example: 00 01 02 03... 08 09 10 11... 19 20 21... 98 99bcd.

3.3.6 Block

The term "block" refers to the data in one logical block; the number of bytes in a block is defined by the logical block length in the mode block descriptor.

3.3.7 Blocks Per Sector

"Blocks per sector" is the number of logical blocks read from each CD-ROM physical sector. The value depends on the logical block length as defined in the mode block descriptor.

3.3.8 CD-DA

Compact Disc-Digital Audio (CD-DA) is the standardized medium for recording digital/audio information. The 'Red Book' defines CD-DA media.

3.3.9 CD-ROM

Compact Disc - Read Only Memory (CD-ROM) is the standardized medium for recording digitized audio and digital data. CD-ROM is used to describe media with digital data rather than discs that encode audio only. The ISO/IEC 10149 standard defines CD-ROM media.

3.3.10 CD-ROM Control Field

The CD-ROM Control Field is a 4-bit field in the Q sub-channel data indicating the type of information encoded on the current track. It indicates audio versus data and the type of audio encoding, etc. The control field is also found in the table of contents entries.

3.3.11 CD-ROM Data Mode

A byte in the header of CD-ROM data sectors. This indicates if data is present and if layered error correction information is present.

3.3.12 Changer

"Changer" is a mechanical device which allows a single physical CD-ROM drive to load and unload multiple CD-ROM without user intervention.

3.3.13 CHS (Cylinder-Head-Sector)

This is an ATA term defining the addressing mode of the drive as being by physical address. This form of addressing is not used by ATAPI Devices.

3.3.14 CIRC

Cross Interleaved Reed-Solomon Code (CIRC) is the error detection and correction technique used within small frames of audio or data. The CIRC bytes are present in all CD-ROM data modes. The error correction procedure which uses the CIRC bytes is referred to as the CIRC based algorithm. In most CD-ROM drives, this function is implemented in hardware.

3.3.15 Command Packet (CP)

“Command Packet” is the structure used to communicate commands from a host computer to an ATAPI device.

3.3.16 Data Block

This term describes a data transfer, and is typically a single sector, except when declared otherwise by use of the Set Multiple command.

3.3.17 DMA (Direct Memory Access)

DMA is a means of data transfer between peripheral and host memory without processor intervention.

3.3.18 Field

A field is a group of one or more contiguous bits.

3.3.19 Frame

A frame is a physical sector on CD-ROM media or the F field unit of a MSF CD-ROM address. The term frame is also used in the CD-ROM model to describe the amount of data received between synchronization patterns. Ninety-eight frames make a sector. This sort of frame is referred to as a ‘small frame’ when the meaning is not clear from the context.

3.3.20 Hold Track State

When a CD-ROM device enters the hold track state the optical pick-up is maintained at an approximately constant position on the media. This allows a paused operation to be resumed without latency due to seeking. However, rotational latency may be incurred.

3.3.21 Index

An index is a subdivision of a CD-ROM track. A track can have from 1 to 99 index numbers. Index numbers within a track are sequential, starting with 1.

3.3.22 Invalid

Invalid refers to an illegal (reserved) or unsupported field or code value.

3.3.23 LBA (Logical Block Address)

The LBA defines the addressing mode of the drive by the linear mapping of sectors from 0 to n.

3.3.24 Logical Block

A Logical Block is a unit of data supplied or requested by a host computer.

3.3.25 Lead-in Area

The Lead-in Area is the area on a CD-ROM disc preceding track one. The main channel in the lead-in area contains audio or data null information. This area is coded as track zero but is not addressable via the ATA CD-ROM command set. The Q sub-channel in this area is coded with the table of contents information.

3.3.26 Lead-out Area

The Lead-out Area is the area on a CD-ROM disc beyond the last information track. The main channel in the lead-out area contains audio or data null information. This area is coded as track AA bcd but is not addressable via the ATA CD-ROM command set. The READ CD-ROM CAPACITY data is the first logical block address of this area minus one.

3.3.27 L-EC

Layered Error Correction (L-EC) is the error correction technique used with CD-ROM (data mode one) sectors. In such sectors, 276 bytes of the auxiliary data field contain L-EC bytes. The algorithm that uses these bytes to perform error correction is often implemented in the drive firmware.

3.3.28 LUN

Logical Unit Number.

3.3.29 Mandatory

“Mandatory” indicates that a referenced item is required to claim compliance with this standard.

3.3.30 MSF Address

The MSF Address is the physical address written on CD-ROM discs. It is expressed as a sector count relative to either the beginning of the medium (absolute) or to the beginning of the current track (relative). As defined by the CD-DA and CD-ROM standards, each F field unit is one physical sector; each S field unit is 75 F field units; each M field unit is 60 S field units. Valid contents of F fields are binary values from 0 through 74. Valid contents of S fields are binary values from 0 through 59. Valid contents of M fields are binary values from 0 through 99.

3.3.31 One

“One” represents a true signal value or a true condition of a variable.

3.3.32 Optional

“Optional” describes features which are not required by the standard. However, if any feature defined by the standard is implemented, it *shall* be done in the same way as defined by the standard. Describing a feature as optional in the text is done to assist the reader. If there is a conflict between text and tables on a feature described as optional, the table *shall* be accepted as being correct.

3.3.33 Output Port

The Output Port is a means for connecting the audio signal being played to equipment outside the CD-ROM device.

3.3.34 Page

Several commands use regular parameter structures that are referred to as pages. These pages are identified with a value known as a page code.

3.3.35 Pause Area

A “pause area” is a transition area at the beginning or end of an audio track encoded with audio silence. This transition area is required where the audio track immediately precedes a data track.

3.3.36 PIO (Programmed Input/Output)

PIO is a means of data transfer that requires the use of the host processor.

3.3.37 Post-gap Area

Post-gap Area is a transition area at the end of a data track encoded with null information. This transition area is required where the data track immediately precedes an audio track.

3.3.38 Pre-gap Area

Pre-gap Area is a transition area at the beginning of a data track encoded with null information. This transition area is required where the data track immediately follows an audio track.

3.3.39 Relative F Field

The sub-division of the S field part of the relative physical address from the beginning of the current track. One physical sector. Written on CD-ROM medium in binary coded decimal notation. The value is from 00bcd to 74bcd.

3.3.40 Relative M Field

Relative M Field is the most significant part of the relative physical address from the beginning of the current track. It is written on CD-ROM media in binary-coded decimal notation. The value is from 00bcd to 99bcd.

3.3.41 Relative S Field

Relative S Field is the intermediate significant part of the relative physical address from the beginning of the current track. It is written on CD-ROM medium in binary-coded decimal notation. The value is from 00bcd to 59bcd.

3.3.42 SAM

SCSI Architectural Model.

3.3.43 Reserved

Reserved bits, fields, bytes, and code values are set aside for future standardization. Their use and interpretation may be specified by future extensions to this or other standards. A reserved bit, field, or byte *shall* be set to zero, or in accordance with a future extension to this standard. The recipient *shall* not check reserved fields.

3.3.44 Sector

“Sector” refers to the data contained by one frame time. (On CD-DA medium with two channels of audio this is 1/75th of a second). In the CD-ROM standard document the term block is used for this unit. There may be more than one logical block per sector. Similarly, a single logical block may map to multiple sectors.

3.3.45 Status

Status is one byte of information sent from the ATA CD-ROM to the host computer upon completion of each command.

3.3.46 Sub-channel

CD-ROM and CD-DA media have a main channel and a sub-channel. The sub-channel area has eight parts called P, Q, R, S, T, U, V, and W. The Q-sub-channel contains information useful to the controller and drive, such as the control field and MSF addresses. The data rate of each sub-channel (P, Q, etc.) is 1/192nd of that of the main channel.

3.3.47 TOC

The table of contents has information on the type of disc and the starting address of the tracks. This information is encoded in the Q sub-channel.

3.3.48 Track

A track is a sub-division of the CD-ROM media. A disc has from one to ninety-nine tracks. The data within a track is always of the same type. A track can be either CD-ROM or CD-Audio. A disc can start at any track number.

3.3.49 Transition Area

Sectors at the beginning or end of tracks that are coded with null information are called transition areas. Where required by the media standards, these areas have minimum lengths. The maximum lengths are not specified. Transition areas at the beginning of a track are encoded with index zero. Addresses within transition areas may not be read.

3.3.50 VU (Vendor Unique)

The term, VU, is used to describe bits, bytes, fields, code values and features which are not described in this standard, and may be used in a way that varies between vendors.

3.3.51 Zero

Zero is a false signal value or a false condition of a variable.

3.4 Symbols and Abbreviations

LSB Least significant bit
LUN Logical unit number
MSB Most significant bit

4.0 ATAPI Overview

The purpose of the ATAPI is to provide a more extensible and general purpose interface than the ATA Task file.

Although the attachment of a CD-ROM on the ATAPI Interface will utilize the ATA Host Hardware and Task File, the logical interface will differ slightly and will need to support additional capabilities. The Mass Storage devices connected to the ATA make use of eight registers (Task File) that contain the command and all parameters needed for operation. However, eight registers is not enough to pass all the needed information for commanding other peripheral types. To remedy this, the ATAPI Device will receive its commands through the use of a Packet mode, in addition to the normal ATA protocol. The Packet Command will complement the existing ATA commands. The ATAPI Device *shall* support all of the ATA specified protocol, including the Reset Master/Slave Diagnostic Sequence, Diagnostic Command, and Command Abort for unsupported Commands. The ATAPI Device *shall* also support both the Master and Slave modes of operation.

4.1 ATA Signal Utilization

ATAPI Devices will utilize the same signals and timing from the ATA Standard and Extensions.

4.2 ATA Command Utilization

The ATA Task File concept does not contain enough bytes to support some of the CD-ROM command structures, so a new command called “ATAPI Packet Command” has been added to allow a Packet to be sent to the Device. The Packet will be transferred by writing multiple times to the Data Register. No random access to the register file in the Peripheral can be done. This technique reduces the number of register addresses needed, but not the actual space needed. Although all the commands for the CD-ROM Device could be sent via this packet mode, some of the existing ATA commands and the full ATA command protocol must be provided for the existing drivers to operate correctly. The CD-ROM Device will therefore support some existing ATA commands in addition to the new “ATAPI Packet command”, so that there will be minimal changes to the existing drivers. This minimal set of ATA commands is different than the minimum as defined in the ATA standard, but should be sufficient for normal operation.

4.3 ATA Compatibility

There are several backward compatibility issues with the existing ATA commands, and therefore the ATAPI CD-ROM Device will respond to the existing ATA Reset Master/Slave Diagnostic Sequence, but not the Identify Drive or Read commands. This will allow the BIOS and older drivers to ignore the CD-ROM Device and not confuse CD-ROM data with normal ATA Drive format data. All unsupported ATA commands *shall* be Aborted, and not executed. As with aborted commands in ATA, an interrupt will be generated to signal the completion with an “aborted” error status.

4.4 Packet Types

To allow for generic packet transfer and the connection of SCSI like peripherals, there *shall* exist a minimum set of information that is exchanged. This information *shall* generically support the following:

- Command Packet (Always padded to number of bytes identified in byte 0 of the identify drive data. 00 = 12 bytes, 01 = 16 bytes)
- Command Parameter Data (e.g. Write Data etc.)
- Command Response Data (e.g. Read Data etc.)
- Status. The Status will not take the form of a packet of information. The status will be presented using the ATAPI Status Register (redefinitions of the ATA Status Register).

Table 2 - Generic Command and Status Usage for ATAPI Devices

Command	Used	Code	Error Register						Status Register				
			BBK	UNC	IDNF	ABRT	TKONF	AMNF	DRDY	DWF	DSC	CORR	ERR
Acknowledge media change	N	DB				V							V
Boot - post-boot	N	DC				V							V
Boot - pre-boot	N	DD				V							V
Check power mode	M	E5				V			V	V	V		V
Door lock	O	DE			V	V			V				V
Door unlock	O	DF				V			V				V
Media eject	N	ED				V			V		V		V
Execute drive diags	M	90	Special Drive Diagnostic Errors										V
Format track	O ¹	50			V	V			V	V	V		V
Identify drive	N	EC				V							V
Idle	O	E3				V			V	V	V		V
Idle immediate	M	E1				V			V	V	V		V
Initialize drive parms	N ²	91				V							V
NOP	M	00				V			V				V
ATAPI Pkt. Command	M	A0	Contains Packet Command Status						V			V	V
ATAPI Identify Device	M	A1				V			V	V	V		V
ATAPI Soft Reset	M	08											
Service	O	A2				V			V				V
Read buffer	N	E4				V							V
Read DMA (w/retry)	N	C8				V							V
Read DMA (wo/retry)	N	C9				V							V
Read long (w/retry)	N ²	22				V							V
Read long (wo/retry)	N ²	23				V							V
Read multiple	N	C4				V							V
Read sector(s) (w/retry)	N ²	20				V							V
Read sector(s) (wo/retry)	N ²	21				V							V
Read verify sector(s) (w/retry)	N ²	40				V							V
Read verify sector(s) (wo/retry)	N ²	41				V							V
Recalibrate	O ¹	1x				V	V		V	V	V		V
Seek	N ¹	7x				V							V
Set features	M	EF				V			V	V	V		V
Set multiple mode	N	C6				V			V	V	V		V
Sleep	M	E6				V			V	V	V		V
Standby	O	E2				V			V	V	V		V
Standby immediate	M	E0				V			V	V	V		V
Write buffer	N	E8				V							V
Write DMA (w/retry)	N	CA				V							V
Write DMA (wo/retry)	N	CB				V							V

Table 2 - Generic Command and Status Usage for ATAPI Devices (Continued)

Command	Used	Code	Error Register						Status Register				
			BBK	UNC	IDNF	ABRT	TKONF	AMNF	DRDY	DWF	DSC	CORR	ERR
Write long (w/retry)	N ²	32				V							V
Write long (wo/retry)	N ²	33				V							V
Write multiple	N	C5				V							V
Write same	N	E9				V							V
Write sector(s) (w/retry)	N ²	30				V							V
Write sector(s) (wo/retry)	N ²	31				V							V
Write verify	N	3C				V							V
Invalid command code						V			V	V	V		V

V = valid on this command
M = Mandatory and *shall* be supported by CD-ROM ATAPI Devices, as specified by the ATA Standard
O = Optional for use by an ATAPI Device
N = Not supported by ATAPI Devices (*shall* be Aborted by the ATAPI Device)
Shaded = Commands are utilized by the ATAPI Devices

1. Although this command is Optional for ATAPI the ATA Standard specifies it as Mandatory.
2. This command is specified as Mandatory for ATA, but *shall* NOT be supported by ATAPI Devices.

4.5 How SCSI is Used by ATAPI

Although the ATAPI Device will utilize many of the actual packet definitions from the SCSI standard, it will NOT use most other features of the normal SCSI Protocol. Thus there are no Phases, no Messages, no sharable bus, (only one Host Computer) and no SCSI Hardware. For those who are familiar with the current SCSI-3 effort, this Standard will not conform with that Packetized Standard.

4.5.1 Differences from the SCSI Standard

Some of the major differences from the SCSI Standard:

- Status will use the ATAPI description, rather than a Data Byte passed at the end of the command.
- ATAPI Device is slave during operation rather than the master view of a SCSI Peripheral.
- No messages are supported.
- No disconnect/reconnect or any of the SCSI Pointers.
- No linking.
- No queueing of commands.
- All CD-ROM Command Packets (CP) are 12 bytes in length, rather than the 6, 8, 10 or 12-byte packets of the SCSI Standard; however, 16-byte ATAPI Command Packets are defined for SAM compatibility for future Devices. The size of the Command Packet required by a Device is defined in word 0 of the ATAPI Identify Device command, allowing Host System Device Drivers to determine the size of the Command Packets before issuing an ATAPI Command Packet.
- No allegiance conditions are used.

This standard will make use of many of the Standard SCSI Command Block definitions and Commands, but some of the commands that would normally be supported by a SCSI Device will not be supported for various reasons. These com-

mands are:

- Reserve and release; as there is only one Host allowed, this is not needed.
- Send and receive diagnostics; the ATA EXECUTE DRIVE DIAGS command replaces these commands.
- Change definitions; as there is no SCSI, this command is nonsensical.
- Copy / Copy and Verify; no shared bus so this command can't be implemented.
- Compare; no shared bus, so this command can't be implemented.
- Read and Write Buffer; simplification.
- Log Sense and Select; simplification.
- Search Data; simplification.
- Verify; simplification.

4.5.2 Redundant Command Functionality (Task File vs. Packet)

The SCSI Standard has provided some commands that the ATA Standard also provides. It is the intent of this standard to allow all the functionality to exist, by utilizing only Command Packets. This will allow existing SCSI like drivers to continue to issue packets for all operation, and have some lower level driver convert them to the ATAPI protocol. Unfortunately there are existing low level drivers that would like to continue to use some non data transfer ATA Task File commands. As such both these "Task File" and "Packet" commands will be supported.

4.5.2.1 Door Lock and Door Unlock vs. Prevent / Allow Medium Removal

There is a need to support a removable Device protocol that allows the Device to send a request to the Host to unlock and/ or Eject the media. There is already an existing methodology that provides this capability in ATA. The device-requested eject is performed by setting the MCR bit in the Error Register and issuing an Error status to the Host (ERR bit in the Status Register) for all subsequent DOOR LOCK commands. The Host would then issue an ACKNOWLEDGE MEDIA CHANGE command to indicate that it will perform the Unlock / Eject sequence. The SCSI PREVENT/ALLOW MEDIUM REMOVAL command only allows the host to "Prevent" the user from removing the media and not to signal when the user needs to remove the media. As such both the ATA and Packet (ATAPI) versions of the commands will be supported. When the ATA Door Lock is used, only the MCR bit will be presented to the host, which can then poll for this condition. When the Packet commands are used the MCR / Door Lock sequence will not be used. The Door Lock / Unlock command is optional, but if the MCR bit is set by the device, it *shall* be supported.

4.5.2.2 ATAPI Identify Drive vs. Inquiry

The ATAPI IDENTIFY DRIVE command has information that the low level drivers use to perform ATA interface hardware configuration. Information in the Identify Drive *shall* continue to look exactly as the ATA Identify Drive does for compatibility reasons. As the information in the Inquiry Command cannot be returned by the ATAPI Identify Drive Command, the Inquiry Command will be supported for use by higher level drivers.

4.5.2.3 Initialize Drive Parameters and Set Features vs. Mode Sense and Mode Select

The INITIALIZE DRIVE PARAMETERS command does not contain a method to provide non ATA device configuration information, and will not be used. As such the Mode Select and Mode Sense from the SCSI standard *shall* be supported. The combination of Mode Select and Set Features commands contain all the necessary functionality and is most compatible with the existing BIOSes and OS Drivers.

5.0 ATAPI Protocol

The ATAPI Device is commanded by two methods, the original ATA Commands utilizing the Task File and the new Packet Command method. For both methods, the devices using this interface *shall* be programmed by the host computer to perform commands and return status to the host at command completion. When more than one Device is daisy chained on the interface, commands are written in parallel to all peripherals, and for ATA commands except the Execute Diagnostics command, only the selected Device (DRV bit in the Drive/Head ATA Register) executes the command. On an Execute Diagnostics command addressed to Device 0, both devices *shall* execute the command, and Device 1 *shall* post its status to Device 0 via PDIAG-.

The “Protocol” for ATAPI centers around the usage of a new ATA Command called “ATAPI Packet Command.” All the normal ATA rules and protocol are used to issue the Packet Command, but once the command has been issued, a new set of rules applies:

1. The interpretation of the DRQ bit in the Status Register *shall* be used along with the Interrupt Reason Registers to determine the actual Interrupt Type.
2. The actual command for the Device to execute is sent as a packet via the data register, and not the Task File.
3. Command arguments are supplied by the Command Packet as well as from the Task File.
4. A Byte Count is used to determine the amount of data the Host *shall* transfer at each DRQ Interrupt.
5. The ATAPI Features Register is used to indicate when DMA will be used rather than by using different opcodes.
6. The final status is presented to the Host as a new interrupt after the last data has been transferred, rather than along with the last block of data.

These new rules (protocol) only apply from after the issuance of the Packet Command, until the Completion Status has been read by the Host. After the Completion Status has been read, the Task File Register definitions and Protocol revert to the standard ATA definition.

5.1 Initialization

The ATAPI Device will respond just as defined in the ATA Standard. The DASP and PDIAG signals will only be utilized following a POR or hardware reset condition. Although the ATA SRST is not used for initialization by ATAPI devices, the “Software reset” defined in the ATA Standard *shall* be utilized.

5.2 ATAPI PACKET Command

The ATAPI Packet Command is issued exactly as normal ATA commands, by initializing the Task File Registers, setting the Drive Selection Bit and writing the Command byte into the Command Register. With normal ATA commands a DRQ (Optional Interrupt) would be generated to indicate that the data for the command could be transferred to/from the Device. With the Packet Command, the first DRQ indicates that the Command Packet Data *shall* be written to the Device. Once the Command Packet has been sent, the command proceeds as a normal ATA command would. The Command Packet bytes *shall* always be transferred via PIO and never using DMA.

ATA Packet Commands can be issued regardless of the state of the DRDY Status Bit.

If while polling BSY the device remains in a state where it cannot accept a command for more than 5 seconds, the Host *shall* time out and reset the device.

Data transfers may be accomplished in more ways than are described by this standard, but the sequences described in this Standard *shall* be used to remain compatible with current and future ATAPI Devices.

5.3 Status Register Utilization for Packet Commands

See "6.7 ATAPI Register Map (Packet Command)" on page 54 for a description of the register definition.

5.4 Byte Count Register (Cylinder Low/High) Usage for Packet Commands

This register is used to control the number of bytes the Host *shall* transfer at each DRQ. It is only used for the command parameter data being transferred via PIO and never for DMA or Command Packet bytes.

Since the length of data that is actually transferred to and from an ATAPI Device using PIO is controlled by the Host, and since the ATAPI Device needs to be able to control the number of bytes transferred, an additional capability was needed. By using the Byte Count Register, a capability to transfer a variable number of bytes has been created. In ATAPI the Device indicates to the Host the number of bytes that *shall* be transferred on each DRQ Interrupt. Before transferring data, the Host *shall* read the 16-bit Byte Count Register, and comply with the length requested. Both the ATAPI Device and the Host will have their own byte counts and will transfer until those counts go to zero. For some commands, such as Mode Sense, the Host does not know the amount of data that will be transferred, and *shall* rely on the Byte Count supplied by the Device to transfer the correct amount of data.

A further capability of the Byte Count Register is for the Host to signal to the ATAPI Device the maximum amount of data it can take in a single PIO DRQ packet and or the preferred packet size. For all commands that require data be transferred, the Host *shall* set the Byte Count Register to the desired length before issuing the Packet Command. This length *shall* be used by the ATAPI Device as the maximum size for each PIO or DMA data packet. The Device can choose to transfer packets smaller than those set by the host in the Byte Count Register.

The Host has the capability to limit the number of bytes transferred on each DRQ. This limit is communicated to the Device in the Byte Count Register when the Packet Command is issued. The Release is intended to be used only on Block Boundaries and since this DRQ limit could then cause a Release in the middle of a block (if the limit is set smaller than the amount of data to be transferred for one sector), the minimum size of the DRQ limit *shall* be no smaller than the length of data to be transferred for one sector from the media. This limitation would only be valid for Media Access commands and not applicable to Mode Sense, Inquiry, etc. If the byte count is odd and the amount of data to be sent is larger than the limit, then the amount of data sent on each DRQ *shall* be less than the specified value as a drive *shall* not send odd length DRQs, except for the last transfer. Given this, the odd byte count transfer limit in the BC registers cannot be used. The device *shall* always round down the value to the next lower even number, unless the transfer length matches the actual total transfer length exactly.

When a Read command is being processed, the ATAPI Device may wish to send all the data that is available in its buffers on just one DRQ Interrupt, with the limitation that only 65534 bytes may be transferred at one time.

Table 3 - Byte Count Register Usage

Operation	Usage (PIO)	Usage (Non-Overlapped DMA)
Send Command Packet	Is used as a parameter to the Packet Command and is not used to control the Packet transfer.	Command Packet is always sent via Programmed I/O and not DMA.
Parameters to the Packet Command (Task File Contents)	As a parameter to any Packet Command that will transfer parameter data, the Byte Count is used by the Host to communicate the maximum / preferred amount of data to be transferred on each DRQ.	The Device can ignore the byte count, as the actual transfers are controlled via the ATAPI Device and not the Host.
Parameter Data from the Device to the Host (e.g. data from a Read, or Inquiry command)	At each DRQ / DMARQ the count contains the number of bytes that the Host <i>shall</i> transfer from the Device.	The ATAPI Device can transfer data whenever it wishes, and as such the Byte Count <i>shall not</i> be used.
Parameter Data from the Host to the Device (e.g. data for a Write, or Mode Select command)	At each DRQ / DMARQ the count contains the number of bytes that the Host <i>shall</i> transfer to the Device.	The ATAPI Device can transfer data whenever it wishes, and as such the Byte Count <i>shall not</i> be used.

If the Device requests more data be transferred than required by the command protocol, the Host *shall* pad when sending data to the Device, and dump extra data into a bit bucket when reading data from the Device.

On odd byte transfers, the only permissible time for an actual Odd Byte Count value will be on the Last DRQ, intermediate DRQs *shall* contain even byte counts.

The peripheral is not responsible for padding the data. Only the specific amount of data specified by the host byte count shall be transferred. Transfers exceeding the host byte count may cause data corruption.

5.5 Sector Count (ATAPI Interrupt Reason) Register Usage for Packet Commands

The Interrupt Reason Register contains an expanded definition of the ATA DRQ Status. When the DRQ is presented in the ATAPI Status Register for an ATAPI Packet Command, the contents of this register indicate if Packet Command or User Data shall be transferred and, if so, the direction of the transfer, as well as Release and Completion State information.

5.6 Immediate Command Operation

Some of the ATAPI Commands are immediate. These commands return Completion Status immediately, with the actual execution of the command continuing. When the actual completion of the seek operation of immediate commands has occurred, the Device shall set the DSC bit in the Status Register.

- ATA commands operate differently from packet commands. When a new ATA command is written to the Command Register, before a command has completed, the executing command stops execution and the new command is aborted with an Aborted Command error.
- If after reporting completion of an Immediate Mode command (Seek, Play Audio, etc.) the device receives a new command before actual completion of the execution of the prior command, the device *shall* accept the new command and execute it when able.
- New ATAPI packet commands received while a previous packet command is still executing shall cause both commands to be aborted with an error, "Check Condition".
- If an Immediate Mode command is executing when the device is issued an SRST the DSC bit *shall* not be cleared with the rest of the status register. Instead the functionality of the DSC bit *shall* be maintained.

5.7 Overlapped Operation

Devices reporting support for Overlapped commands are capable of improving system performance by releasing the ATA bus to another device before completing a command in progress. For more detail see "5.17 Overlapped Command Operation" on page 39.

5.7.1 Example of ATAPI Overlap with only one ATAPI Peripheral

- ATAPI Drive Releases the Task File Ownership after acceptance of an ATAPI command.
- Overlap Mode is enabled on each command via the ATAPI Features Register.
- Overlapped Commands are issued to an ATA (Legacy) Drive while an ATAPI Command is still processing.
- Interrupts are generated from the selected device only. Thus the Driver must always select the Overlap capable device when there is no active command to a Legacy Device.
- Device uses Interrupt & SERVICE Status to gain Host's attention. SERVICE Status set when any service is needed.
- Driver uses the A2h (Service) Command to give control of the Task File Registers back to the Device after an Interrupt and Sensing the SERVICE status bit.
- The Interrupt Reason RELEASE Status bit is used to indicate a Release Interrupt.

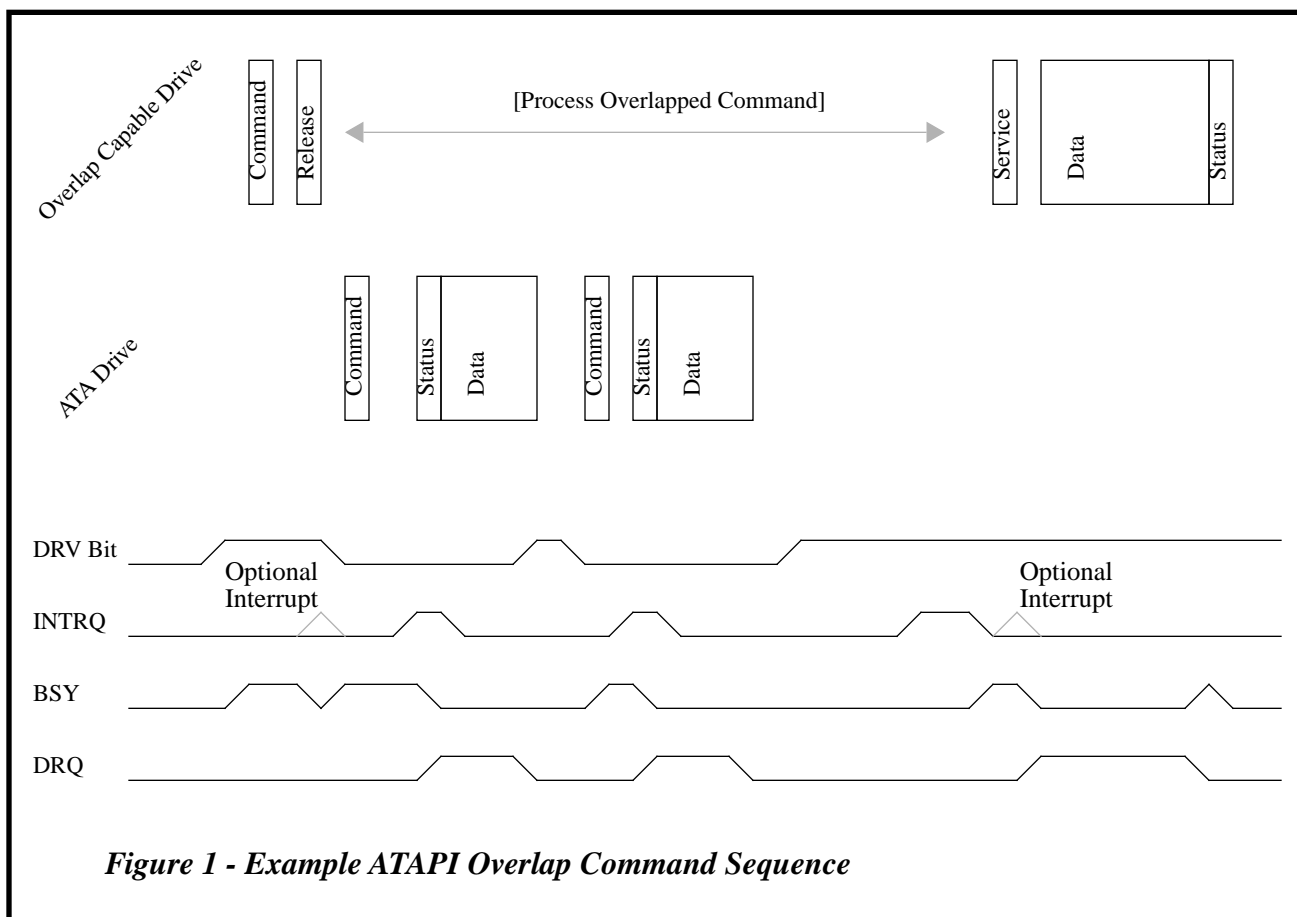

5.8 Flow of Packet Command, PIO Data In to Host

This class includes commands such as Inquiry, Read etc. Execution includes the transfer of some unknown number of data bytes from the Device to the host.

1. The host Polls for BSY=0, DRQ=0 then initializes the task file by writing the required parameters to the Features, Byte Count, and Drive/Head registers.
 2. The host writes the Packet Command code (A0h) to the Command Register.
 3. The Device sets BSY, before the next system read of the status register, and prepares for Command Packet transfer.
 4. When the Device is ready to accept the Command Packet, the Device sets CoD and clears IO. DRQ *shall* then be asserted simultaneous or prior to the de-assertion of BSY. Some Devices will assert INTRQ following the assertion of DRQ. See section 7.1.7.1, "General Configuration Word (0)", on page 63 for command packet DRQ types and other related timing information.
 5. After detecting DRQ, the host writes the 12 bytes (6 words) of Command to the Data Register.
 6. The Device(1) clears DRQ (when the 12th byte is written), (2) sets BSY, (3) reads Features and Byte Count requested by the host system, (4) prepares for data transfer.
 7. When data is available, the Device:(1) places the byte count of the data available into the Cylinder High and Low Registers, (2) sets IO and clears CoD, (3) sets DRQ and clears BSY, (4) sets INTRQ.
 8. After detecting INTRQ, the host reads the DRQ bit in the Status Register to determine how it *shall* proceed with the command. If DRQ= 0 then the device has terminated the command. If DRQ=1 then the host *shall* read the data (number of bytes specified in the Cylinder High/Low Registers) via the Data Register. In response to the Status Register being read, the Device negates INTRQ for both cases.
 9. The Device clears DRQ. If transfer of more data is required, the Device also sets BSY and the above sequence is repeated from step 7.
 10. When the Device is ready to present the status, the Device places the completion status into the Status Register, sets CoD, IO, DRDY and, prior to asserting INTRQ, clears BSY and DRQ.
 11. After detecting INTRQ & DRQ=0 the host reads the Status Register and if necessary, the Error Register for the command completion status.
- The DRQ signal is used by the device to indicate when it is ready to transfer data, and is cleared during the last byte of data to be transferred. This applies for both Command Packet as well as normal read/write data.

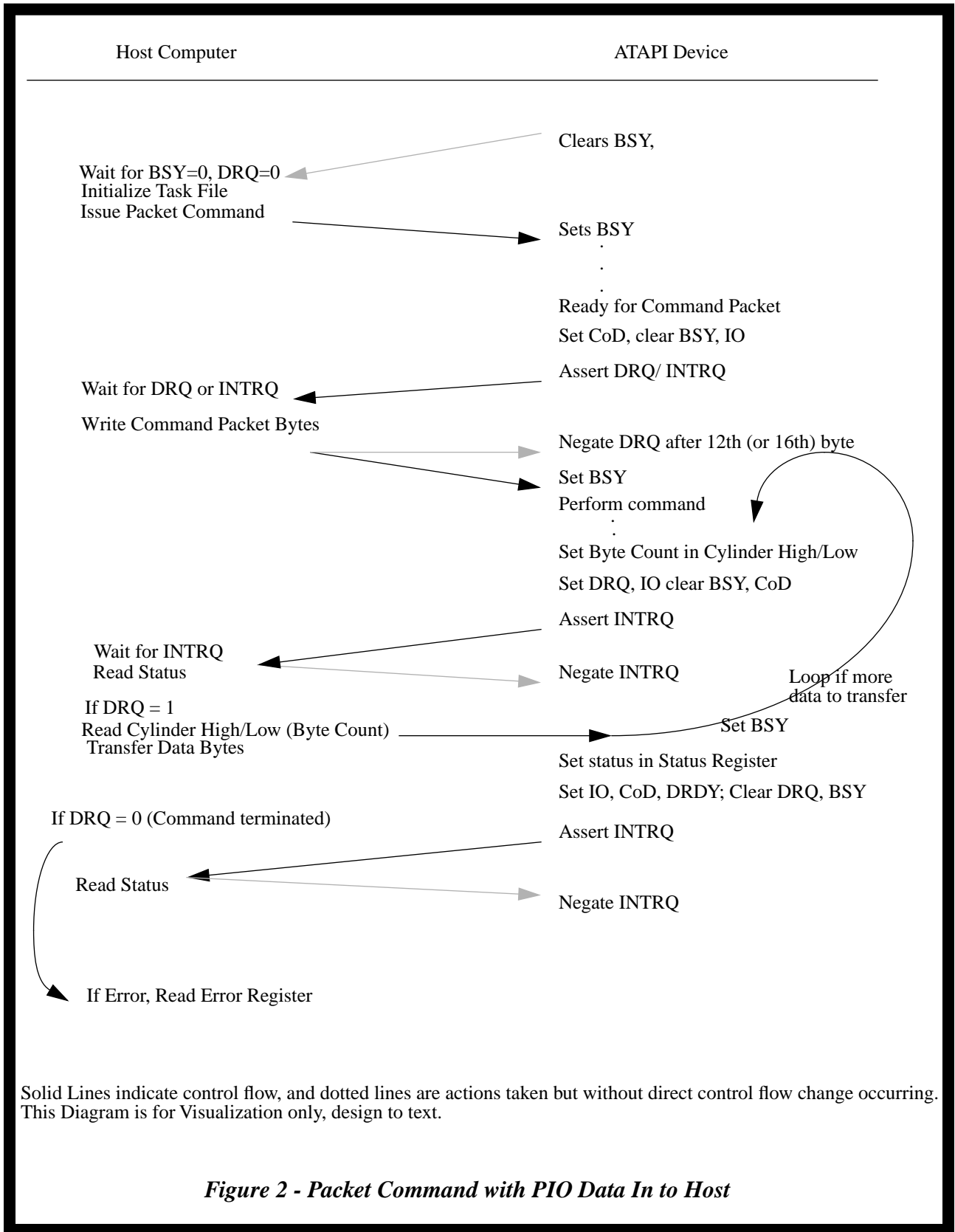

5.9 Flow of Overlapped Commands with Data Transfer In to Host

This class includes commands such as Inquiry, Read etc. Execution includes the transfer of some unknown number of data bytes from the Device to the host.

1. The host Polls for BSY=0, DRQ=0 then initializes the task file by writing the required parameters to the Features, Byte Count, and Drive/Head registers. The OVERLAP bit in the ATAPI FEATURES Register must be set (1).
2. The host writes the Packet Command code (A0h) to the Command Register.
3. The Device sets BSY, before the next system read of the status register, and prepares for Command Packet transfer.
4. When the Device is ready to accept the Command Packet, the Device sets CoD and clears RELEASE, IO. DRQ *shall* then be asserted simultaneous or prior to the de-assertion of BSY. Some Devices will assert INTRQ following the assertion of DRQ. See section 7.1.7.1, "General Configuration Word (0)", on page 63 for command packet DRQ types and other related timing information.
5. After detecting DRQ, the host writes the 12 bytes (6 words) of Command to the Data Register.
6. The Device(1) clears DRQ (when the 6th word is written), (2) sets BSY, (3) reads Features and Byte Count requested by the host system, (4) prepares for either Release of the ATA Bus or Data Transfer.
7. If the Device has NOT been previously commanded to generate an interrupt after accepting the Packet Command Data, the Device may optionally not release the ATA Bus. In this case the device *shall* move directly from accepting the Command Packet Data to Data Transfer (Step 12. below) with DRQ=1, CoD=0 and IO = 0. This must also be done within the time reported the Identify Drive Data Command Data. See "7.1.7.16 Typical Time for the Release After Command Received (Word 71)" on page 67. If the Device has been commanded to generate an interrupt after processing the Packet Command, the Device *shall* always release the ATA Bus.
8. The Device (1) sets the RELEASE bit in the ATAPI STATUS Register, (2) clears IO, CoD, DRQ, (3) clears BSY. If the Device has been previously commanded to generate an interrupt when releasing the ATA Bus after receiving a Packet Command, the Device *shall* set INTRQ (1).
9. Released State.

---- At this point the Host is free to select the other Device and Issue Commands ----

--- When the Host is Not using the Non Overlapped Device it selects the Overlap Device allowing it to interrupt ---

10. When the Device is ready to accept data, the Device (1) sets the SERVICE Bit in the ATAPI STATUS Register, (2) sets DRQ, (3) sets INTRQ.
11. After detecting INTRQ, the Host *shall* read the ATAPI STATUS Register to determine if the selected device is requesting service. If there is an overlapped command active on the non-selected device, the Host *shall* change the DRV Bit and read the ATAPI STATUS Register to determine if service is also needed on the non-selected Device. When the state of both Device's SERVICE bits are known the Host *shall* select one of the Devices, that is requesting service, and issue the Service (A2h) Command. The Host *shall* employ some fairness technique in choosing which Device will be serviced.
12. When the Device receives the Service Command or if moving directly from Packet Command Data to Data Transfer or from Back-to-Back Data Transfers, the Device (1) places the byte count of the data available into the Cylinder High and Low Registers, (2) clears SERVICE, (3) sets IO and clears CoD, (4) sets DRQ and clears BSY. If

the Device has been previously commanded to generate an interrupt when done processing the Service Command, the Device *shall* set INTRQ (1).

13. After detecting INTRQ or that BSY has been cleared, the host reads the DRQ bit in the Status Register to determine how it will proceed with the command. If DRQ= 0 then the device has either released the ATA Bus or terminated the command. If DRQ=1 then the host *shall* read the data (number of bytes specified in the Cylinder High/Low Registers) via the Data Register. In response to the Status Register being read, the Device negates INTRQ for both cases.
14. If no more data is to be transferred, proceed to step 19.
15. One of two possibilities exists, either Release or back-to-back data transfers. If Release, proceed to Step 17.
16. The device (1) sets Busy; (2) clears DRQ; and (3) the Release bit is cleared. The IO CoD bits remain the same. Proceed to step 12.
17. The Device (1) leaves BSY cleared, (2) clears DRQ. The RELEASE Bit *shall* have been set at the beginning of the last data transfer. The IO and CoD bits *shall* remain in the same state as for a normal data transfer, this distinguishes the "Release" from a "Status" state.
18. The above sequence is repeated from step 9.
19. The Device clears DRQ and sets BSY.
20. The Device places the completion status into the Status Register, sets CoD, IO, DRDY, clears RELEASE, BSY, and DRQ, prior to asserting INTRQ.
21. After detecting INTRQ & DRQ=0, the host reads the Status Register and if necessary, the Error Register for the command completion status. If the Host detects that the RELEASE Bit or that both IO and CoD are not set this is not a status state but a release state and should proceed accordingly.

The DRQ signal is used by the device to indicate when it is ready to transfer data, and is cleared after (during) the last byte of data to be transferred. This applies for both Command Packet as well as normal read/write data.

The RELEASE Bit is used to signal that the Drive has released the ATA Bus. The RELEASE Bit *shall* be qualified by the host with both BSY and DRQ cleared. If either BSY or DRQ is set, then the value in the RELEASE bit is undefined.

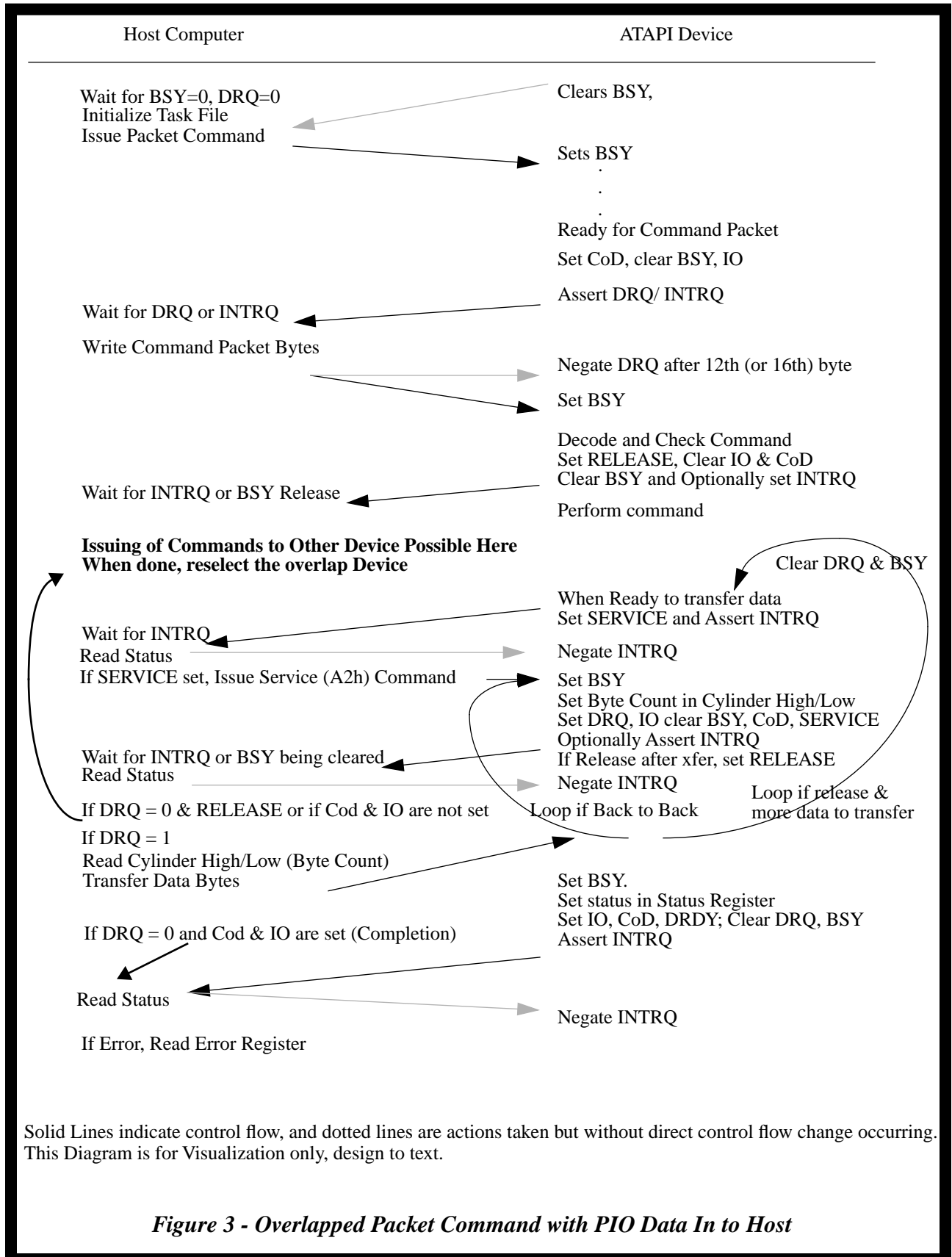

5.10 Flow of Packet Command with PIO Data Out from the Host

This class includes commands such as Mode Select, Write etc. Execution includes the transfer of some known number of data bytes from the Host to the Device.

1. The host Polls for BSY=0, DRQ=0 then initializes the task file by writing the required parameters to the Features, Byte Count, and Drive/Head registers.
2. The host writes the Packet Command code (A0h) to the Command Register.
3. The Device sets BSY, before the next system read of the status register, and prepares for Command Packet transfer.
4. When the Device is ready to accept the Command Packet, the Device sets CoD and clears IO. DRQ *shall* then be asserted simultaneous or prior to the de-assertion of BSY. Some Devices will assert INTRQ following the assertion of DRQ. See section 7.1.7.1, "General Configuration Word (0)", on page 63 for command packet DRQ types and other related timing information.
5. After detecting DRQ, the host writes the 12 bytes (6 words) of Command to the Data Register.
6. The Device(1) clears DRQ (when the 12th byte is written), (2) sets BSY, (3) reads Features and Byte Count requested by the host system, (4) prepares for data transfer.
7. When ready to transfer data, the Device:(1) sets the byte count (Cylinder High and Low Registers) to the amount of data that the Device wishes to be sent, (2) clears IO and CoD, (3) sets DRQ and clears BSY, (4) sets INTRQ. The Byte Count would normally be set to the number of bytes requested by the contents of the register at the receipt of the command, but may be any amount that the Device can accommodate in its buffers at this time.
8. After detecting INTRQ, the host reads the DRQ bit in the Status Register to determine how it shall proceed with the command. If DRQ= 0 then the device has terminated the command. If DRQ=1 then the host *shall* write the data (number of bytes specified in the Cylinder High/Low Registers) via the Data Register. In response to the Status Register being read, the Device negates INTRQ for both cases.
9. The Device clears DRQ and sets BSY. If transfer of more data is required, the above sequence is repeated from 7.
10. When the Device is ready to present the status, the Device places the completion status into the Status Register, sets CoD, IO, DRDY and clears BSY, DRQ, prior to asserting INTRQ.
11. After detecting INTRQ & DRQ=0 the host reads the Status Register and if necessary, the Error Register for the command completion status.

The DRQ signal is used by the device to indicate when it is ready to transfer data, and is cleared after (during) the last byte of data to be transferred. This applies for both Command Packet as well as normal read/write data.

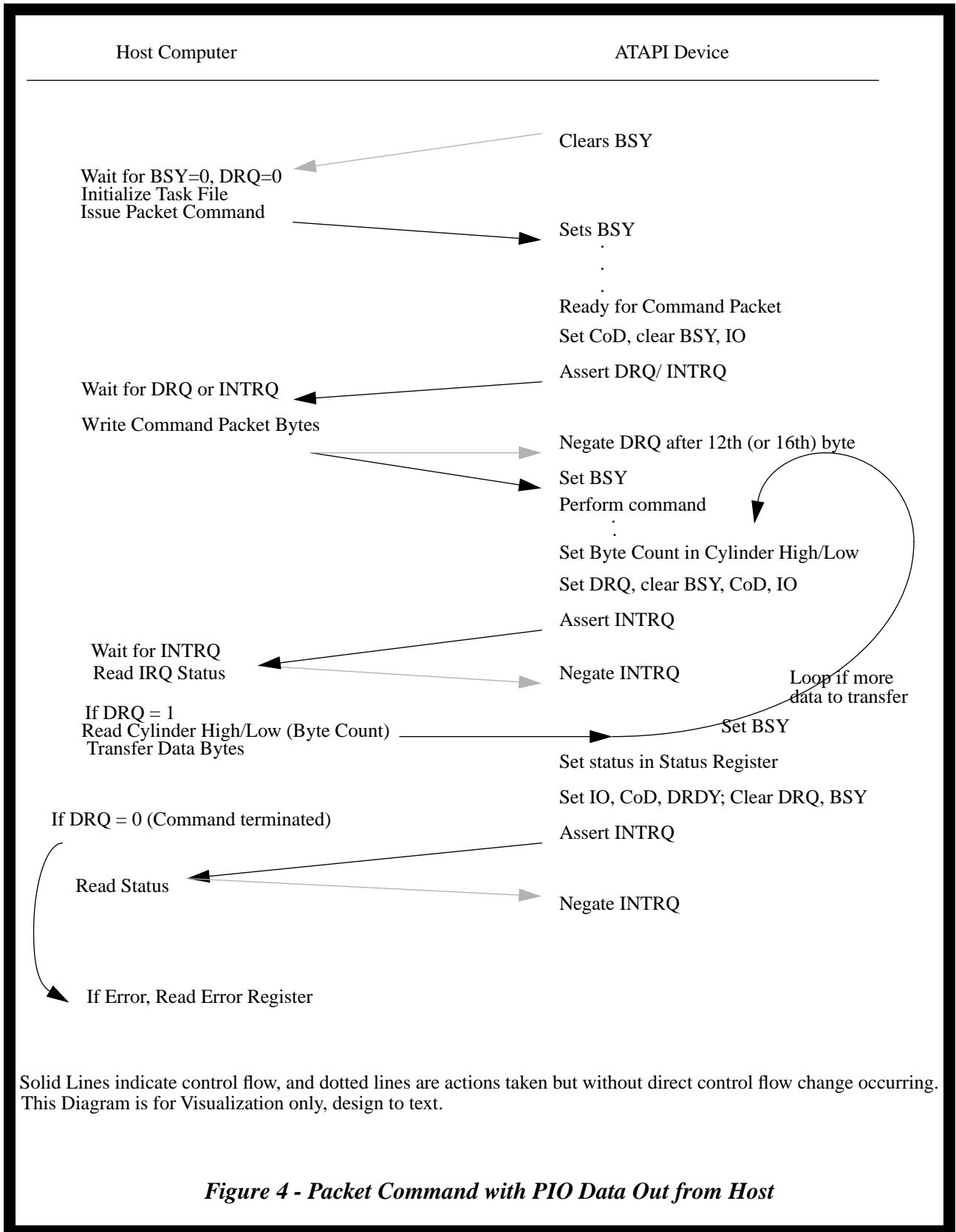

5.11 Flow of Overlapped Commands with Data Transfer Out From Host

This class includes commands such as Mode Select, Write etc. Execution includes the transfer of some unknown number of data bytes from the Host to the Device.

1. The host Polls for BSY=0, DRQ=0 then initializes the task file by writing the required parameters to the Features, Byte Count, and Drive/Head registers. The OVERLAP bit in the ATAPI FEATURES Register must be set (1).
2. The host writes the Packet Command code (A0h) to the Command Register.
3. The Device sets BSY, before the next system read of the status register, and prepares for Command Packet transfer.
4. When the Device is ready to accept the Command Packet, the Device sets CoD and clears RELEASE, IO. DRQ *shall* then be asserted simultaneous or prior to the de-assertion of BSY. Some Devices will assert INTRQ following the assertion of DRQ. See section 7.1.7.1, "General Configuration Word (0)", on page 63 for command packet DRQ types and other related timing information.
5. After detecting DRQ, the host writes the 12 bytes (6 words) of Command to the Data Register.
6. The Device(1) clears DRQ (when the 6th word is written), (2) sets BSY, (3) reads Features and Byte Count requested by the host system, (4) prepares for either Release of the ATA Bus or Data Transfer.
7. If the Device has NOT been previously commanded to generate an interrupt after accepting the Packet Command Data, the Device may optionally not release the ATA Bus. In this case the device must move directly from accepting the Command Packet Data to Data Transfer (Step 12. below) with DRQ=1, CoD=0 and IO = 0. This must also be done within the time reported the Identify Drive Data Command Data. See "7.1.7.16 Typical Time for the Release After Command Received (Word 71)" on page 67. If the Device has been commanded to generate an interrupt after processing the Packet Command, the Device *shall* always release the ATA Bus.
8. The Device (1) sets the RELEASE bit in the ATAPI STATUS Register, (2) clears IO, CoD, DRQ, (3) clears BSY. If the Device has been previously commanded to generate an interrupt when releasing the ATA Bus after receiving a Packet Command, the Device *shall* set INTRQ (1).
9. Released State.

---- At this point the Host is free to select the other Device and Issue Commands ----

--- When the Host is Not using the Non Overlapped Device it selects the Overlap Device allowing it to interrupt ---

10. When the Device is ready to accept data, the Device (1) sets the SERVICE Bit in the ATAPI STATUS Register, (2) sets DRQ, (3) sets INTRQ.
11. After detecting INTRQ, the Host *shall* read the ATAPI STATUS Register to determine if the selected device is requesting service. If there is an overlapped command active on the non-selected device, the Host *shall* change the DRV Bit and read the ATAPI STATUS Register to determine if service is also needed on the non-selected Device. When the state of both Device's SERVICE bits are known the Host *shall* select one of the Devices, that is requesting service, and issue the Service (A2h) Command. The Host *shall* employ some fairness technique in choosing which Device will be serviced.
12. When the Device receives the SERVICE Command or if moving directly from Packet Command Data to Data Transfer or from Back-to-Back Data Transfers, the Device (1) places the byte count of the data available into the Cylinder High and Low Registers, (2) clears SERVICE, (3) clears IO and CoD, (4) sets DRQ and clears BSY. If

the Device has been previously commanded to generate an interrupt when done processing the SERVICE Command, the Device *shall* set INTRQ (1).

13. After detecting INTRQ or that BSY has been cleared, the host reads the DRQ bit in the Status Register to determine how it will proceed with the command. If DRQ= 0 then the device has either released the ATA Bus or terminated the command. If DRQ=1 then the host *shall* write the data (number of bytes specified in the Cylinder High/Low Registers) via the Data Register. In response to the Status Register being read, the Device negates INTRQ for both cases.
14. If no more data is to be transferred, proceed to step 19.
15. One of two possibilities exists, either Release or back-to-back data transfers. If Release, proceed to Step 17.
16. The device (1) sets Busy; (2) clears DRQ; and (3) the Release bit is cleared. The IO CoD bits remain the same. Proceed to step 12.
17. The Device (1) leaves BSY cleared, (2) clears DRQ. The RELEASE Bit *shall* have been set at the beginning of the last data transfer. The IO and CoD bits *shall* remain in the same state as for a normal data transfer, this distinguishes the “Release” from a “Status” state.
18. The above sequence is repeated from step 9.
19. The Device clears DRQ and sets BSY.
20. The Device places the completion status into the Status Register, sets CoD, IO, DRDY, clears RELEASE, BSY, and DRQ, prior to asserting INTRQ.
21. After detecting INTRQ & DRQ=0, the host reads the Status Register and if necessary, the Error Register for the command completion status. If the Host detects that the RELEASE Bit or that both IO and CoD are not set this is not a status state but a release state and should proceed accordingly.

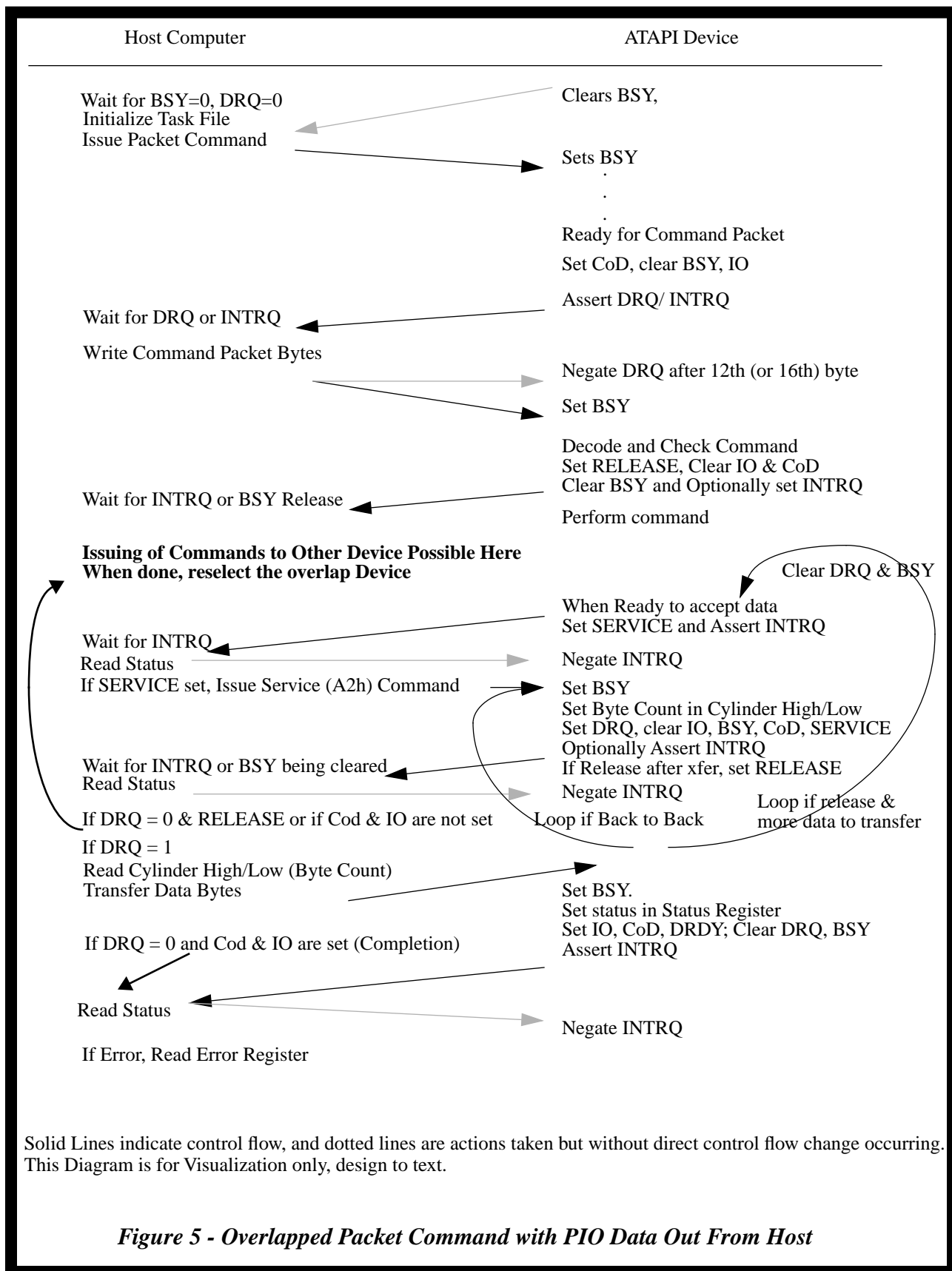

5.12 Flow of Non-Overlap DMA Data Commands

This class includes commands such as Read, Write etc. Execution includes the transfer of some unknown number of data bytes.

1. The host Polls for BSY=0, DRQ=0 then initializes the task file by writing the required parameters to the Features, Byte Count, and Drive/Head registers. The host must also initialize the DMA engine which will service the Devices requests.
2. The host writes the Packet Command code (A0h) to the Command Register.
3. The Device sets BSY and prepares for Command Packet transfer.
4. When the Device is ready to accept the Command Packet, the Device sets CoD and clears IO. DRQ *shall* then be asserted simultaneous or prior to the de-assertion of BSY. Some Devices will assert INTRQ following the assertion of DRQ. See section 7.1.7.1, "General Configuration Word (0)", on page 63 for command packet DRQ types and other related timing information.
5. After detecting DRQ, the host writes the 12 bytes (6 words) of Command to the Data Register.
6. The Device(1) clears DRQ (when the 12th byte is written), (2) sets BSY, (3) reads Features and Byte Count requested by the host system, (4) prepares for data transfer.
7. When ready to transfer data, the Device transfers via DMARQ/DMACK any amount that the Device can accommodate or has in its buffers at this time. This continues until all the data has been transferred.
8. When the Device is ready to present the status, the Device places the completion status into the Status Register, and sets IO, CoD, DRDY and clears BSY, DRQ, prior to asserting INTRQ.

After detecting INTRQ the host reads the Status Register for the command completion status.

5.13 Flow of Non-data Commands

This class includes commands such as Seek, etc. Execution of these commands involves no data transfer.

1. The host Polls for BSY=0, DRQ=0 then initializes the task file by writing the required parameters to the Features, Byte Count, and Drive/Head registers.
2. The host writes the Packet Command code (A0h) to the Command Register.
3. The Device sets BSY and prepares for Command Packet transfer.
4. When the Device is ready to accept the Command Packet, the Device sets CoD and clears IO. DRQ *shall* then be asserted simultaneous or prior to the de-assertion of BSY. Some Devices will assert INTRQ following the assertion of DRQ. See section 7.1.7.1, "General Configuration Word (0)", on page 63 for command packet DRQ types and other related timing information.
5. After detecting DRQ, the host writes the 12 bytes (6 words) of Command to the Data Register.
6. The Device sets BSY and executes the command.
7. When the Device is ready to present the status, the Device places the completion status into the Status Register, and sets IO, CoD, DRDY and clears BSY, DRQ, prior to asserting INTRQ.
8. After detecting INTRQ, the host reads the Status Register for the command completion status.

5.14 Timing of Non-Overlap Packet Command

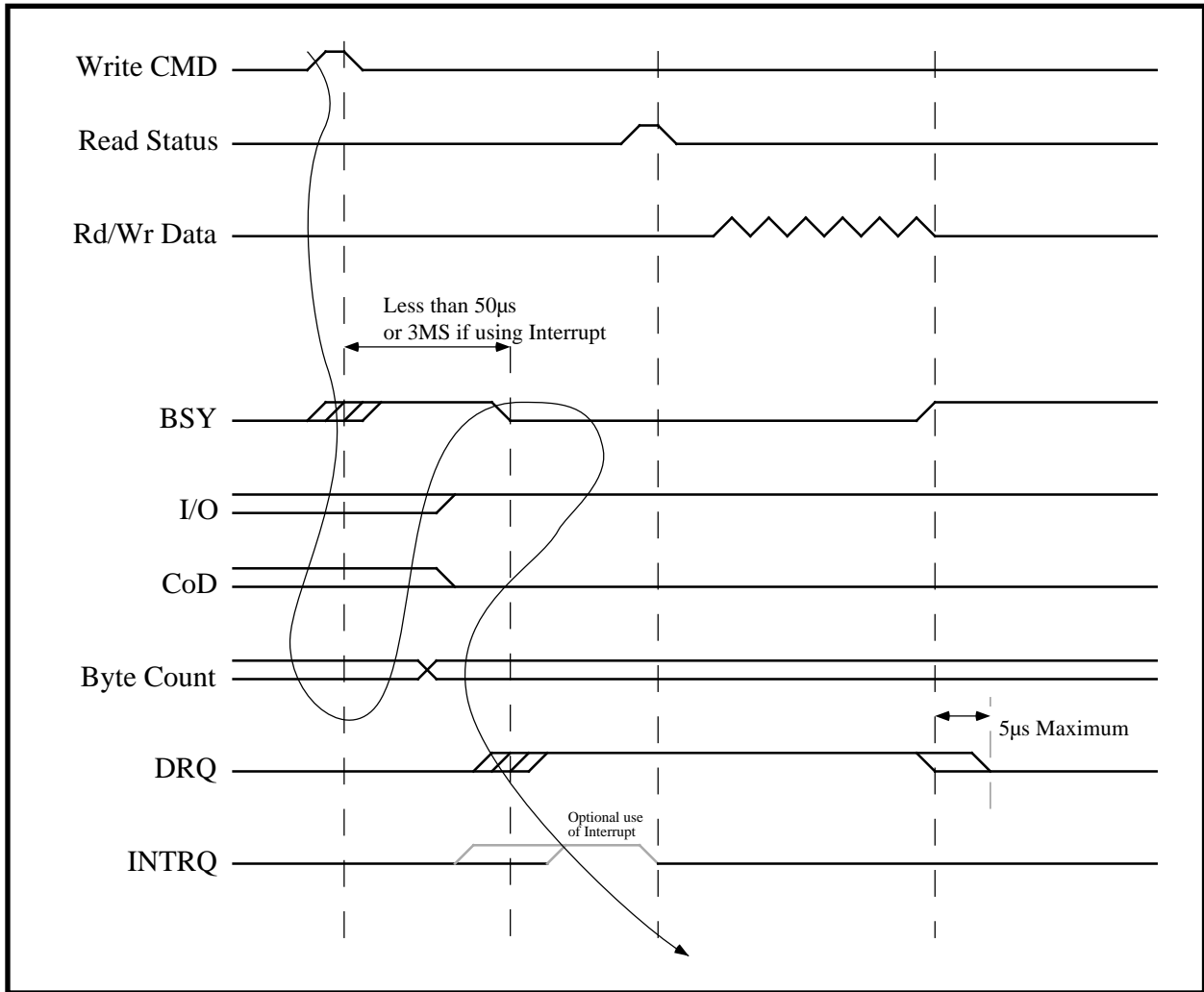

Figure 6 - Timing of Command Packet Transfer

5.15 Timing of Non-Overlap Data and Status Transfer

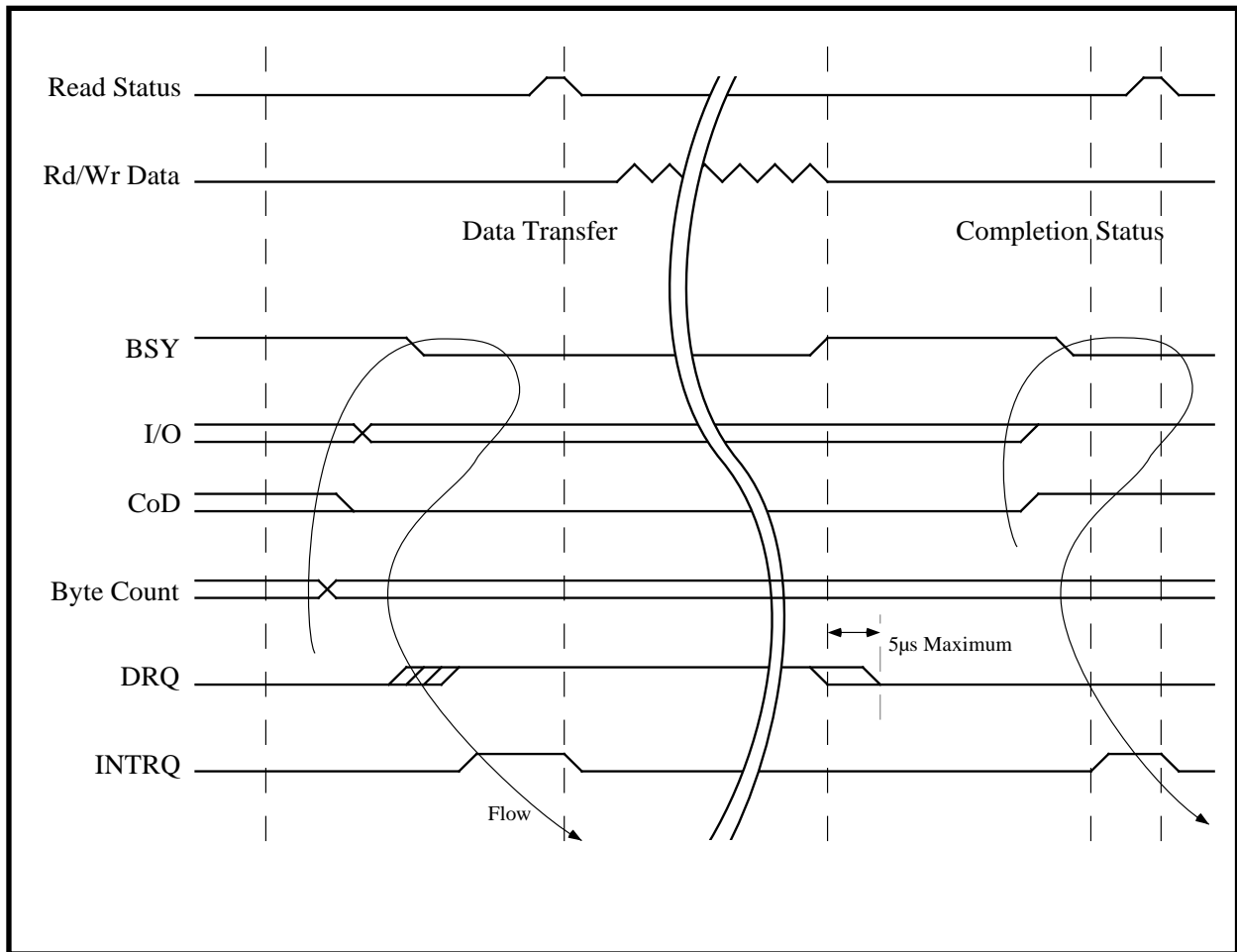

Figure 7 - Timing of Data and Status Transfer

5.16 Control Signal Timing Requirements and Relationships

The order that the signals change *shall* adhere to the following conditions:

1. Upon receiving the A0h ATAPI Packet Command the Device *shall* have BSY asserted until the next host access of the Status Register where the device can guarantee that CoD=1 and IO=0.
2. The Device *shall* not assert DRQ until CoD and IO are valid for the command or data packet to be transferred and the device is ready to perform that transfer.
3. The Device *shall* clear BSY and set DRQ within the time-out specified by the CMD DRQ Type. See section 7.1.7.1, "General Configuration Word (0)", on page 63 for additional information.
4. Devices reporting CMD DRQ Type "Accelerated" *shall* de-assert DRQ within 5us of the last word transferred for a command or data packet unless Back-to-Back Data Transfers in an overlapped mode are performed.
5. Devices reporting a CMD DRQ Type other than "Accelerated" *shall* de-assert DRQ, before asserting INTRQ, following the last word transferred for a command or data packet.

Implementer's Note: Early ATAPI Devices reporting CMD DRQ Types other than "Accelerated" may not be able to de-assert DRQ before the next INTRQ. Host systems should therefore wait until the device asserts INTRQ before testing DRQ following the transfer of the last data word in a command or data packet.

See section 7.1.7.1, "General Configuration Word (0)", on page 63 for additional DRQ and other timing related information.

5.17 Overlapped Command Operation

Devices reporting support for Overlapped commands are capable of improving system performance by releasing the ATA bus to another device before completing a command in progress. The host system can enable this feature by setting the OVERLAP bit in the Feature Register when it issues an ATAPI Packet command. The device uses the RELEASE bit in the ATAPI Interrupt Reason register to notify the host that it has released the ATA bus before it has completed the command in progress.

- Releasing the ATA bus to another device is at the discretion of the device processing an Overlapped command. Devices should only Release the ATA Bus, before a command has completed, when the host will not need to service an Interrupt or DRQ from the device for more than the time specified in words 71 and 72 of the devices identify drive data. This is typically the cases for seeks on mechanically slower devices such as CD-ROM and Tape.
- When the host detects a “Release” from a device to which it has sent an overlapped command, the DRV bit may be changed to select another device and issue a command.
- Changing the DRV bit while BSY or DRQ are set may cause the currently selected device to abort any command in progress.
- The normal protocol for Non-Overlapped commands requires that the command complete before the host can select another device. This means that the host will not be able to access the Overlapped device again until the non overlapped device completes any command the host may issue to it.
- To ensure fairness between slower Overlapped and faster Non-Overlapped devices sharing the same ATA channel, the host should poll the slower Overlapped devices SERVICE bit before issuing each new command to the faster non-Overlapped device.
- When the host detects that the SERVICE bit in the ATAPI STATUS Register is set, a Service (A2h) command *shall* be issued before any task file registers besides ATAPI STATUS are valid.
- Slower Overlapped devices may release control of the ATA bus several times while processing an overlapped command.
- DMA Operation for an overlapped command will make use of a new protocol. This “Overlapped DMA protocol” will cause the ATA bus to be released after a specified number of data bytes have been transferred.
- When DMA data is to be transferred, the protocol sequence used for PIO will be followed. When data is to be transferred a Service Interrupt will be generated. No data will be transferred until the Service (A2h) command has been received by the Device.
- The number of bytes that will be transferred is specified in the BYTE COUNT Register after the Service (A2h) command has been processed. After the specified number of bytes is transferred the ATA bus *shall* either be released or held busy until data or status are available.
- At the completion of data transfer or within 5µs, either a Release or a Back-to-back data transfer *shall* be initiated.

5.17.1 Release

One of the capabilities that is the foundation for Overlapped operation is Release. There are three different forms of release used in this specification, after the receipt of a Command, after transferring some data and after the receipt of the Service Command.

This specification will allow the device to implement these release operations either in the Firmware or in Hardware. Each of these release points has its own complexities. For example before the Task File Registers can be released after the receipt of a command, the Command and parameter information must be saved. Once the release is performed the contents of the Task File Registers can no longer be used by the Device. Although this save would seem simple, adding a complete set of shadow registers is expensive and will not allow the device to perform command queuing that may be proposed in future versions of this specification. For command queuing there must be separate registers/memory locations for each of the commands that can be queued. Thus if the device supports 16 commands, then 16 back to back commands could be sent to the device by the host faster than the device could process them. The device could have only one set of shadow registers and only automatically release the Task File Registers when moving the standard set into the shadow set, but this would incur delays for release when the second command was loaded if the first had not yet been processed by the device. This would thus cause inconsistent delays until the Task File Registers were released.

This specification assumes the device will consistently unload the information in the Task File Registers. Although holding the BSY longer in some cases would most likely be acceptable from a system performance standpoint, forcing the driver to poll for varying lengths of time is not. This specification forces the device to report the typical length of time that the device will require to unload and then Release the Task File Registers. Further to reduce the length of time that the Driver would have to poll for the Release, this specification has an Interrupt on Release Capability.

The Interrupt on Release capability is enabled by the Host Driver using a SET FEATURES Command. To assist the Driver in determining if the Interrupt should be enabled the IDENTIFY DRIVE Command returns the length in microseconds that the device will use to Release for both an Overlapped Command and the Service Command. The Driver can then make its own decision to enable the interrupt. Thus if the Device reports 1000 μ s, the Driver could decide that it wants to poll and not enable the interrupt (Unlikely).

The Release after the transfer of data *shall* be performed by hardware for all data transfer operations and as such there is no Interrupt generated after the release when transferring data. An optional Back-to-Back Data Transfer without a Release or IRQ can be used by a device.

5.17.2 Service Command (A2h)

The Arbitration of the Task File Registers is performed by logic outside of the Devices attached to the ATA Cable. The basic premise is that the Device releases the use of the Task File Registers when it is processing the command and no longer needs the registers. This of course makes it difficult to place the arguments for the Interrupt into the registers as the device no longer owns them. The Service command essentially hands the registers back to the device so that the correct parameters can be placed into them. These parameters include the Byte Count, and Interrupt Reason.

The Clearing of Busy after the Service Command *shall* only occur after the parameters for the Interrupt are loaded into the Task File Registers. Thus for a hardware implementation of this Clearing of Busy, there should exist a separate set of information for these parameters e.g. Byte Count, Interrupt Reason, Status. Note, in the future, acceleration of the Service Command will become very important to the overall system performance when using overlap. It is highly recommended that the time required to perform the Clearing of Busy after the SERVICE Command is less than 5 μ s.

When an overlapped command requests service the Host Driver is responsible for determining which device should be serviced, and then issuing the Service Command. This causes the device to place information on the reason for the service into the Task File registers.

5.17.3 Overlapped Operation, Legal Transitions

Table 5 - Legal Transitions for Overlapped Operation

State From	State To	Reason	Sequence	Notes
Idle	Cmd Packet	Host Issues A0h	BSY=1, CoD=1, IO=0, DRQ=1, BSY=0	
Cmd Packet	Release	Command ok, but no data is ready to be transferred	BSY=1, DRQ=0, RELEASE=1, CoD=0, IO=0, BSY=0, INTRQ=1 if Interrupt on Release After Command Packet is enabled	The time required by the Device to perform the Release is specified in Word 71 of the Identify Drive Data
Cmd Packet	Data Transfer	Command ok and Data is ready to be Sent/Received	BSY=1, DRQ=0, CoD=0, IO=1/0, RELEASE=0, DRQ=1, BSY=0, INTRQ=1	The assertion of DRQ <i>shall</i> occur within the time specified in word 71 of the Identify Drive Data
Data Transfer	Release	# of bytes specified by the Byte Count Register has been transferred	RELEASE=1, DRQ=0 (BSY stays=0, CoD & IO Stay the same)	The Release <i>shall</i> occur within 5µs after transferring the last word of data
Data Transfer	Data Transfer	# of bytes specified by the Byte Count Register has been transferred	BSY=1, DRQ=0, Byte Count = new count (CoD & IO stay the same), DRQ=1, BSY=0, INTRQ=1	The assertion of DRQ <i>shall</i> occur within 5µs after transferring the last word of data from the previous data transfer
Release	Service	Data or Status is ready for the Host	SERVICE=1, DMA READY=0/1, INTRQ=1	Requests that the Host Arbitrate and Issue the Service Command.
Service	Data Transfer	Service Command issued and Data can be transferred	BSY=1, IO=1/0, CoD=0, Byte Count=x, DRQ or DMARQ=1 (DMA READY stays the same), BSY=0, INTRQ=1 if Interrupt on Service Completion is enabled	
Service	Status	Service Command issued and Status is available	BSY=1, IO=1, CoD=1, RELEASE=0, DRQ=0, BSY=0, INTRQ=1 if Interrupt on Service Completion is enabled	This is not a recommended transition. After transferring the data the device should set BSY until the status is available
Data Transfer	Status	# of bytes specified by the Byte Count Register has been transferred	BSY=1, RELEASE=0, DRQ or DMARQ=0, CoD=1, IO=1, BSY=0, INTRQ=1	BSY <i>shall</i> be set within 5µs after transferring the last word of data if status will not be available within the 5µs window

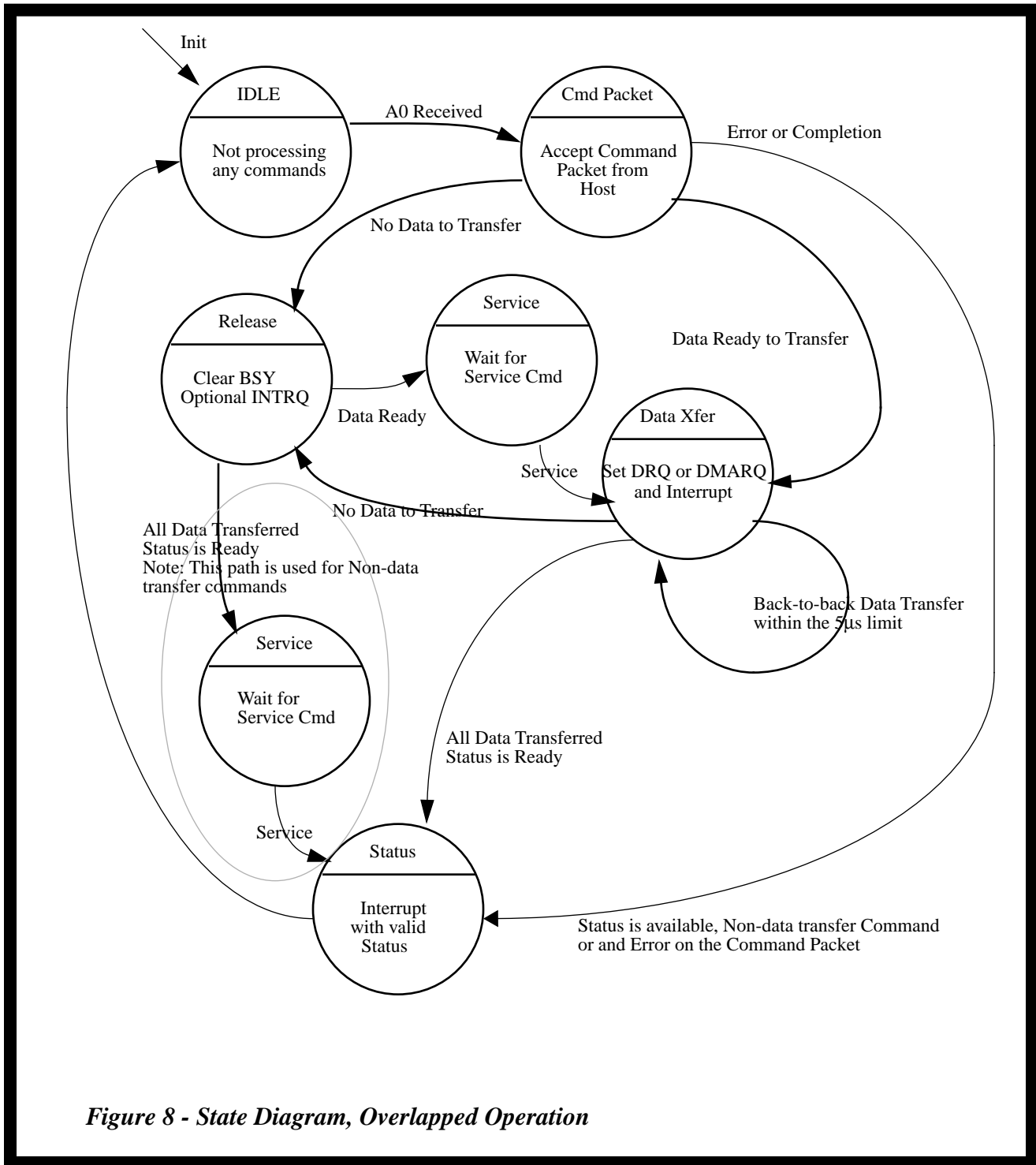

Figure 8 - State Diagram, Overlapped Operation

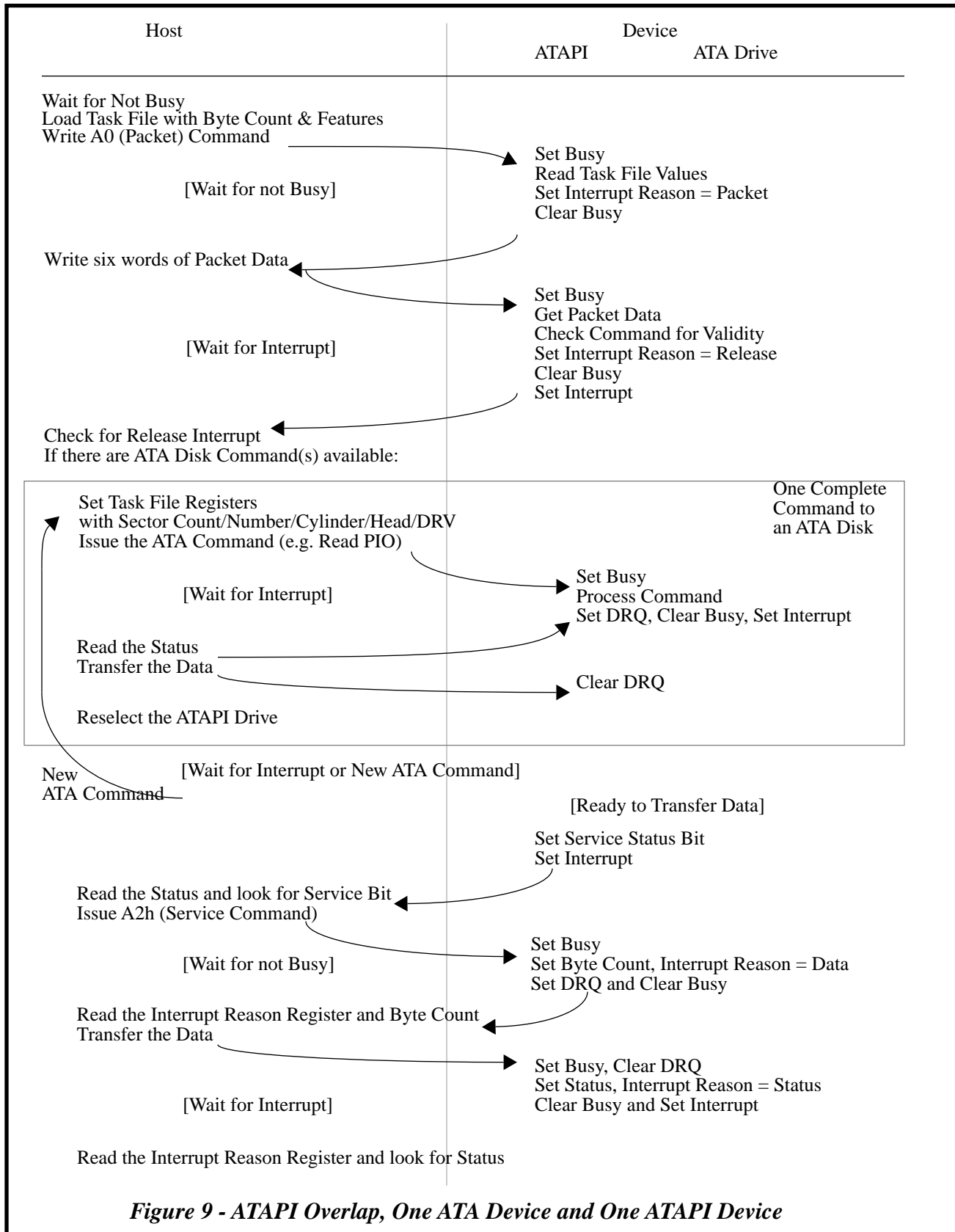

Figure 9 - ATAPI Overlap, One ATA Device and One ATAPI Device

5.17.4 Task File ownership

When BSY or DRQ is set, the Task File Registers are owned by the Device, otherwise the Registers are owned by the Host. When the Device does not own the Registers, it *shall* not write to into them. The "Table 6 - Registers Controlled by BSY & DRQ" on page 45 shows which of the ATA Registers are considered part of the "Owned" Task File Registers.

Logic conventions are: A = signal asserted, N = signal negated, x = does not matter which it is.
Dark Gray are registers where ownership is controlled by BSY & DRQ.
Light Gray are Registers that are not defined for use by ATA.

Addresses					Functions	
CS1FX	CS3FX	DA2	DA1	DA0	Read (DIOR-)	Write (DIOW-)
A	N	0	0	0	Data	
A	N	0	0	1	Error Register	Features
A	N	0	1	0	ATAPI Interrupt Reason / Sector Count	
A	N	0	1	1	Sector Number	
A	N	1	0	0	ATAPI Byte Count LSB / Cylinder Low	
A	N	1	0	1	ATAPI Byte Count MSB / Cylinder High	
A	N	1	1	0	Drive Select	
A	N	1	1	1	Status	Command
N	A	0	0	0	Floppy A Status	Unused
N	A	0	0	1	Floppy B Status	Unused
N	A	0	1	0	Unused	Floppy Digital Output
N	A	0	1	1	Floppy ID / Tape Control	RESERVED
N	A	1	0	0	Floppy Controller Status	RESERVED
N	A	1	0	1	Floppy Data Register	
N	A	1	1	0	Alternate Status	Device Control
N	A	1	1	1	Change / Drive Address	Unused

Table 6 - Registers Controlled by BSY & DRQ

5.17.5 Error Handling with Overlapped Commands

An issue can arise with because overlapped commands are enabled on a Command by Command basis. If an overlapped command is in progress and a non-overlapped command is then received, the Device must abort without any status any outstanding overlapped command.

In overlapped operation there will be intermediate command status, as well as the final command completion status. The intermediate status is supplied to indicate if the command was accepted. If the command is not accepted, then there will be no further status supplied. The intermediate status is the status at the point that the device releases the Task File registers back to the host, prior to executing the command. Thus this status can only relate to the validity of the command and not any command execution.

5.18 BIOS and ATAPI Driver Compatibility

This section discusses the IDE features and functions that *shall* be provided by the ATA Device to allow the BIOS and driver to be content.

5.18.1 Reset Master/Slave Diagnostics Sequence

A Reset Master/Slave Diagnostics Sequence with a Good Status *shall* be provided or the BIOS will not continue. When the CD-ROM is the slave device, and it does not respond after the Reset or Diagnostic Commands, the Master Device will return an Error Condition to the Host Computer and all will die.

5.18.2 SRST Initialization Sequence

The SRST bit in the ATAPI Device Control Register (See “Table 17 - ATAPI Device Control Register (ATA Device Control Register)” on page 57) *shall* NOT be used by the ATAPI Driver (except for power management when SRST is used to wake up an ATAPI device). Instead the ATAPI Device Driver *shall* reset the ATAPI Device utilizing the ATAPI Soft Reset command (see “6.2 ATAPI Soft Reset Command and Protocol” on page 50). Resetting the ATAPI Device using the ATA SRST would also reset any ATA hard drive attached, and if there are separate Drivers for an IDE and an ATAPI device, each driver would be resetting the others peripheral without the other driver being aware of the reset.

5.18.2.1 SRST Sequence Device 0

1. Host sets SRST bit to one.
2. Device 0 sets BSY within 400 nsec.
3. Device 0 Posts diagnostic results in the Error Register.
4. Device 0 waits for the Host to clear SRST to zero.
5. If Device 0 detected that Device 1 is present during the most recent power on or hardware reset sequence, then Device 0 waits up to 31 seconds from the time that SRST bit became zero for Device 1 to assert PDIAG-. If PDIAG- is asserted within 31 seconds, Device 0 clears bit 7 of the Error Register to zero, else Device 0 sets bit 7 equal to one in the Error Register. If Device 1 was not detected in the most recent power up or hardware reset sequence, then Device 0 clears bit 7 of the Error Register to zero.
6. Device 0 loads the ATAPI Signature into the Task File Registers.
7. Device 0 Clears the BSY bit to zero when ready to accept commands within 31 seconds after the SRST bit was cleared to zero.

5.18.2.2 SRST Sequence Device 1

1. Host sets SRST bit to one.
2. Device 1 sets BSY within 400 nsec.
3. Device 1 negates PDIAG- within 1 msec after SRST is set to one.
4. Device 1 Posts diagnostic results in the Error Register.
5. Device 1 waits for the Host to clear SRST to zero.
6. Device 1 loads the ATAPI Signature into the Task File Registers.
7. Device 1 Clears the BSY bit to zero when ready to accept commands within 31 seconds after the SRST bit was cleared to zero.
8. If Device 1 didn't post any error, assert PDIAG-, else optionally assert PDIAG-.

5.18.2.3 Other SRST Related Issues

A value other than 00h in the status register prior to the receipt of the first ATAPI Command Packet from the host may cause ATAPI Devices to be incorrectly identified by pre-ATAPI host BIOS as an ATA-compatible disk drive.

Initializing the task file upon receipt of an SRST works since only immediate commands will be executing when an ATA disk driver issues an SRST. To prevent interruption of ATAPI immediate commands which have not finished executing, the function of the DSC bit (i.e. command complete) *shall* be maintained. On a warm boot the BIOS and/or drivers may see a status of 00h or 10h, depending on whether or not an ATAPI immediate command completed at the same time the system performed the WARM BOOT.

The signature placed in the task file following an SRST *shall* remain until the ATAPI device receives its first ATAPI command, i.e., the ATAPI device will look NOT READY (DRDY=0). This will not affect the ATAPI device drivers ability to send ATAPI commands to the ATAPI device since it is not required to wait for DRDY=1. However, it will prevent ATA-compatible drivers, such as those performing power management, from sending commands to an ATAPI device until the ATAPI device has received its first ATAPI command: ATAPI Packet Command, ATAPI Identify Device, ATAPI Soft Reset.

ATAPI drivers wishing to use ATA power management commands must poll DRDY and, if it is not set, they must also look at the Cylinder registers for the ATAPI signature. If the signature is present, the ATAPI driver must issue the ATAPI device an ATAPI command, re-enabling DRDY, before it can issue an ATA Power management command. Operating systems wishing to use a common ATA power management driver must also be changed to perform this detection and recovery sequence, if they intend to power-manage ATAPI devices.

5.18.3 Special Handling of ATA Read and Identify Drive Commands

ATAPI drivers *shall* not issue SRST since it may corrupt the state of ATA IDE drives sharing the same cable. Instead, ATAPI drivers *shall* use the ATAPI Soft RESET command to initialize an ATAPI device. Note that ATAPI commands shall not be issued to a device which has not already been identified as an ATAPI device. In order to provide ATAPI drivers with the ability to force a device to initialize its ATAPI signature (Cylinder High = EBh, Cylinder Low = 14h) without issuing an SRST, ATAPI devices *shall* abort the ATA Read and Identify Drive commands and initialize the task file with the ATAPI signature before clearing BSY.

5.18.4 ATAPI aware BIOS and Driver Considerations

Pre-ATAPI BIOS will not detect or configure ATAPI devices. Some of these BIOS are capable of configuring ATA hard disks for ATA Mode 3 IORCHDY operation. This places a special burden on ATAPI drivers to detect the presence of any ATA disk drives sharing the same port address and configure the ATAPI device for a compatible mode of operation.

Note that a special IDE port configuration driver must be provided by the IDE card manufacturer to configure the cards proprietary IDE configuration control registers. These proprietary IDE card drivers should be loaded before the ATAPI driver.

During ATAPI device detection, ATAPI device drivers or ATAPI-aware BIOS should verify that Status=00h (Not BSY, Not RDY) and that the ATAPI signature Cylinder High = EBh, Cylinder Low = 14h are present. If an ATAPI device is detected, then issue an ATAPI Identify Command to complete the ATAPI detection protocol and re-enable the task file (DRDY=1). If the device is ready to accept an ATA command, but no ATAPI signature is detected, then issue an ATA

Read or Identify Drive command to the device to force the ATAPI device to initialize its signature. Then wait for BSY=0 and re-verify the presence of the ATAPI signature. If there is still no ATAPI signature present, do not configure the device.

ATAPI-aware BIOS and drivers should give special attention to managing configurations where ATAPI drivers share an IDE port address (Cable) with ATA IDE drives and their drivers. ATA IDE drivers frequently issue SRSTs to manage errors thereby causing ATAPI devices to clear DRDY as part of their SRST ATAPI signature initialization sequence. If the ATAPI driver already knows that the device it wishes to issue an ATAPI command to is an ATAPI device, then it need not take special action since issuing any of the ATAPI commands which do not require DRDY=1, will restore the ATAPI device's ability to accept ATA commands. If, however, the ATAPI driver wishes to issue an ATA command to an ATAPI device which has received an SRST from an ATA IDE driver, it should issue the ATAPI device an ATAPI Soft Reset to restore the ATAPI device's ability to accept ATA commands.

Note that "Newer" BIOS detect the presence of a Drive (see "4.3 ATA Compatibility" on page 17) by using the IDENTIFY DRIVE command, but older BIOS use configuration information from outside the IDE/ATA interface. It has also been discovered that very old BIOS may issue an ATA READ command to detect the presence of an ATA IDE drive. Therefore, the ATA READ and IDENTIFY DRIVE commands *shall* be aborted by ATAPI Devices. It has also been discovered that some BIOS look at the status register to detect the presence of an ATA drive.

Implementer's Note: *Implementers of ATAPI drivers which are intended to share a single cable with a disk and disk driver should ensure that the device has completed any issued commands prior to changing the DRV bit.*

5.18.5 Default Timing

It is recommended that ATAPI devices compatible with this specification, support ATA mode 3 timing without requiring the host system to configure the ATAPI device using any set features commands. ATAPI devices should therefore either be fast enough to always supply data at the maximum rate allowed by Mode 3 or the ATAPI device must be shipped with IORDY enabled.

ATAPI devices *shall* revert to their default interface configuration on a Power On Reset or a Hardware Reset.

Implementer's Note: *A Non-Overlapped low-speed drive, Mode 0-2, may affect system performance when sharing the same cable with hard disk drives capable of mode 3 or faster data transfer timing.*

6.0 ATAPI Transport Mechanism

The Transport Mechanism provides for the hardware support to connect the host computer to the Peripheral.

6.1 Reset Conditions

There are three types of Reset Condition to which ATAPI Devices shall respond:

- **Power On Reset or Hardware Reset:** the Device executes a series of electrical circuitry diagnostics and sets default values, as well as executing the Master Slave Diagnostic Protocol.
- **ATAPI Soft Reset:** ATAPI Devices *shall* reset the interface circuitry according to the Set Features requirement upon receipt of the ATAPI Soft Reset Command.
- **ATA SRST:** ATAPI Devices *shall* provide the normal ATA PDIAG/ DASP sequence and initialize the task file with the ATAPI signature upon detection of SRST. No actual reset of the ATAPI device will occur, no commands that may be active will be aborted or stopped.

The Reset Conditions above are listed in order of precedence. That is, Power On or Hardware Reset *shall* take precedence over ATAPI Soft Reset, which *shall* take precedence over ATA SRST, which *shall* take precedence over all other conditions.

6.1.1 Power On or Hardware Reset

Each ATAPI Device, as it is powered on, *shall* perform appropriate internal reset operations, and internal test operations.

ATAPI Devices upon detection of reset, *shall*:

1. Clear all Commands and I/O operations in progress.
2. Return to Devices default configuration.
3. Perform the DASP / PDIAG sequence (See "*Figure 10 - DASP / PDIAG Sequence after Hardware Reset or Power On*" on page 50).
4. Return any ATAPI Device operating modes to their appropriate initial conditions, similar to those conditions that would be found after a normal power-on reset. MODE SELECT conditions *shall* be restored to their last saved values if saved values have been established. MODE SELECT conditions for which no values have been saved *shall* be returned to their default values.
5. Initialize the Task File Registers as follows: Status = 00h, Error = 01h, Sector Count = 01h, Sector Number = 01h, Cylinder Low = 14h, Cylinder High = EBh and Drive/Head = 00h. A value other than 00 in the status register prior to the receipt of the first ATAPI Command Packet from the host may cause the ATAPI Device to be incorrectly identified by the host as an ATA compatible disk drive. BSY = 0, following any Reset, indicates to the Host that the registers within the Task File have been initialized.

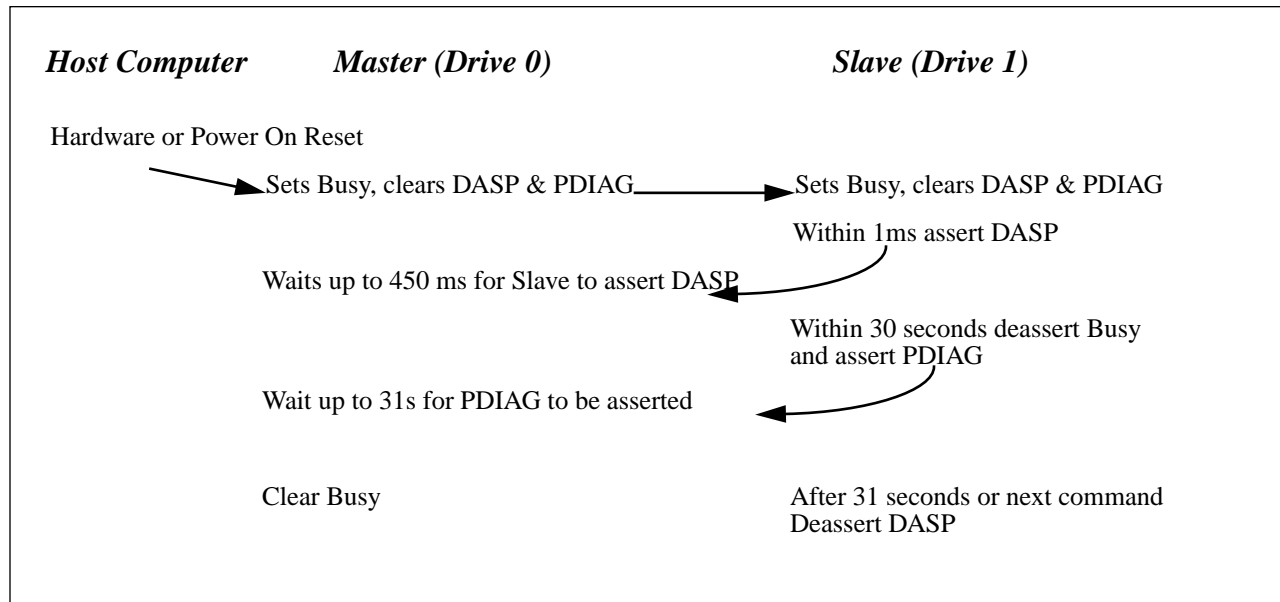

Figure 10 - DASP / PDIAG Sequence after Hardware Reset or Power On

6.2 ATAPI Soft Reset Command and Protocol

ATA specifies a mandatory software reset capability because it provides a recovery mechanism from a class of errors/problems that are recoverable in no other way. The current CD-ROM drivers invoke this feature at some point in their error recovery procedures today.

The ATA software reset mechanism, SRST, (bit 2 in the Device Control Register) cannot be used for ATAPI Devices, because resets issued by the ATAPI driver would also reset any attached hard disk and vice versa.

For a software reset to be useful, it must be able to bring the drive's microprocessor back from a busy or hung condition, allowing issuance of a diagnostic or some other command. Since the microprocessor is the destination of the reset, we can't depend on it as part of the reset path. Therefore, ATAPI Soft Reset *shall* be detected/decoded by the interface controller circuitry and be routed back to the microprocessor as a hardware signal.

Upon detection of the ATAPI Reset command, *shall*:

1. Set BSY. When the reset sequence in the Device is complete the Busy status will be cleared. This will be the only status returned to the host by the ATAPI Soft Reset command.
2. Initialize the task file with the same information as after a Power On Reset. See section 6.1.1, "Power On or Hardware Reset", on page 49 for a description of the initialization sequence, with the exception of the DRV bit which *shall* remain unchanged.

6.3 ATAPI Implementation of ATA SRST

The ATA software reset mechanism, SRST, (bit 2 in the Device Control Register) cannot be used for ATAPI Devices, because resets issued by the ATAPI driver would also reset any attached hard disk and vice versa. To solve this ATAPI defines an ATAPI Soft Reset command using a reserved ATA opcode which could be decoded by the interface controller hardware.

To maintain Master / Slave compatibility with ATA disk drives and prevent detection of ATAPI Devices by non ATAPI-aware BIOS, ATAPI Devices *shall* implement the following upon receipt of an ATA SRST:

1. Perform SRST PDIAG sequence see "*5.18.2 SRST Initialization Sequence*" on page 46.
2. Initialize the task file with Status = 00h or 10h, Error = According to SRST Sequence, Sector Count = 01h, Sector Number = 01h, Cylinder Low = 14h, Cylinder High = EBh and Drive/Head = 00h. Note that Device 0 will be selected after the completion of the SRST sequence.
3. The functionality of the DRDY and DSC bits shall be restored on the first command following an SRST.
4. Continue executing commands or play operations.
5. Leave Mode settings or Set Feature settings unchanged.
6. If a selected ATAPI Device detects SRST while its own DRQ or BSY is set (1), then the command in progress *shall* be stopped.

6.4 Physical Connection

The ATAPI Devices are selected by the Address field in the Drive Select Register. When the ATAPI Device is attached along with an ATA Mass Storage Device, the ATAPI Device should be set as Device 1 and respond as a Slave.

Table 7 - Preferred Drive Connection

Primary Cable		Secondary Cable		Notes
Drive 0	Drive 1	Drive 0	Drive 1	
ATA				Normal, no ATAPI
ATA		ATAPI		Disk and CD-ROM for enhanced IDE system
ATA	ATAPI			Legacy IDE System with only one cable
ATA		ATAPI	ATAPI	Enhanced IDE with CD-ROM and a tape or two CD-ROMs

6.5 Single Drive Configurations

There can be either one or two drives attached to the ATA Cable, and thus four configurations are possible. Even though there are four possible configurations, only three of them are recommended. An ATAPI Peripheral *shall* detect each of these three configurations and respond according to "Table 8 - Shadow Registers" on page 52.

There are configurations where there may be only one Master or Slave present on the cable. In this case there will be a "Shadowing" of the registers for the non-existent device. The following table shows the actions to take.

Table 8 - Shadow Registers

Jumper ->	Device	Configuration	Action
Master	0	Don't Care	Drive Bus
	1	Slave Present	Float Bus
	1	Slave Not Present	Shadow
Slave	0	Master Present	Float Bus
	0	Master Not Present	This is not a recommended Configuration. Float Bus
	1	Don't Care	Drive Bus
CSEL=M	0	Don't Care	Drive Bus
	1	Slave Present	Float Bus
	1	Slave Not Present	Shadow
CSEL=S	0	Master Present	Float Bus
	0	Master Not Present	This is not a recommended Configuration. Float Bus
	1	Don't Care	Drive Bus

Table 9 - Shadowing for Single Drive Configurations

Drive 0 Register Description	Drive 1 (Non-existent Slave) Use of the Register
Control Block Registers	
Alternate ATAPI Status	This may be either be a complete duplicate of the Drive 0 Status (Shadowed) or Some of the bits are explicitly for Drive 1 (e.g. ERROR)
Device Control	Writing to this register writes to Drive 0's Device Control Register
Command Block Registers	
Data	Should not be used for the non-existent slave
ATAPI Error Register	This may be either be a complete duplicate of the Drive 0 ATAPI Error Register or the Register is explicitly for Drive 1 (Not Shadowed)
ATAPI Features	Writing to this register writes to Drive 0's ATAPI Features Register
ATAPI Interrupt Reason Register	These are an exact duplicate of Drive 0's register. Implementer's Note: <i>As the Signature is placed in these Registers, both Drive 0, and the non-existent Drive 1 will have an "ATAPI Signature" after a reset condition. To detect that Drive 1 does not exist will require a command be issued to Drive 1 and detecting the Abort.</i>
ATAPI Byte Count Register (bits 0-7)	
ATAPI Byte Count Register (bits 8-15)	
Drive Select	Writing to this register writes to Drive 0's Drive Select Register
ATAPI Status	This may be either be a complete duplicate of the Drive 0 Status (Shadowed) or Some of the bits are explicitly for Drive 1 (e.g. ERROR)
ATA Command	Commands to Drive 1 will be aborted. Implementer's Note: <i>The Error bit will need to be set to abort a command to Drive 1, if the Status and Alternate Status Registers are complete shadows of Drive 0's Register, changing the DRV bit and reading the Status Register will also show an error condition that does not exist. It is recommended that the ERROR bit not be shadowed, but a separate bit for the non-existent drive 1.</i>

Implementer's Note: Drive 0 (Master) is able to determine if Drive 1 (Slave) is present, but Drive 1 can't determine if Drive 0 is present. Drive 0 will see the Slave drive assert the DASP- signal during the Reset procedure, which indicates that the Slave is present.

6.6 Register Mapping

Communication to or from the Devices is through I/O Registers that route the input or output data to or from registers (selected) by a code on signals from the host (CS1FX-, CS3FX-, DA2, DA1, DA0, DIOR- and DIOW-).

6.7 ATAPI Register Map (Packet Command)

Logic conventions are: A = signal asserted, N = signal negated, x = does not matter which it is

Table 10 - I/O Port Functions/Selection Addresses (Compatibility Model)

Addresses					Functions	
CS1FX	CS3FX	DA2	DA1	DA0	Read (DIOR-)	Write (DIOW-)
					Control Block Registers	
N	A	0	0	0	Floppy A Status	Unused
N	A	0	0	1	Floppy B Status	Unused
N	A	0	1	0	Unused	Floppy Digital Output Register
N	A	0	1	1	Floppy ID / Tape Control	RESERVED
N	A	1	0	0	Floppy Controller Status	RESERVED
N	A	1	0	1	Floppy Data Register	
N	A	1	1	0	Alternate ATAPI Status	Device Control
N	A	1	1	1	<i>Note</i> ¹	Not Used
					Command Block Registers	
A	N	0	0	0	Data	
A	N	0	0	1	ATAPI Error Register	ATAPI Features
A	N	0	1	0	ATAPI Interrupt Reason Register	Unused
A	N	0	1	1	Reserved For SAM TAG Byte	
A	N	1	0	0	ATAPI Byte Count Register (bits 0-7)	
A	N	1	0	1	ATAPI Byte Count Register (bits 8-15)	
A	N	1	1	0	Drive Select	
A	N	1	1	1	ATAPI Status	ATA Command

1. This register is obsolete. It is recommended that a device not respond to a read of this address. If a device does respond, it *shall* not drive the DDF signal.

With the exception of the Data Register, all the ATAPI registers are referenced using Byte (8 Bit) Read and Writes. The Data Register is ALWAYS referenced as a 16 bit word.

Table 11 - ATAPI Status Register (ATA Status Register)

D7	D6	D5	D4	D3	D2	D1	D0	
BSY	DRDY	DMA READY or DF	SERVICE or DSC	DRQ	CORR	Reserved	CHECK	Read

DRDY, DSC, CORR and CHECK *shall* only be valid at the end of the completion of the command.

- | | | |
|---|----------------|--|
| Bit 7 | BSY | Busy is set whenever the drive has access to the Command Block. |
| Bit 6 | DRDY | Indicates that the drive is capable of responding to an ATA command. |
| Bit 5 | DMA READY / DF | This bit indicates that the device is ready to start a DMA data transfer. This bit is reserved for future more advanced overlap capabilities. |
| <i>Note that this bit is used for Drive Fault (DF) when Overlapped or Interleaved DMA operation is not enabled.</i> | | |
| Bit 4 | SERVICE / DSC | This bit signals that the device is requesting service or interrupt. It is set when the interrupt is requested and does not clear until the Service (A2h) command is issued. |
| <i>Note that this bit is used for the DSC function when the overlap function is not enabled.</i> | | |
| Bit 3 | DRQ | Data Request - Indicates that the device is ready to transfer a word or byte of data between the host and the drive. The information in the ATAPI Interrupt Reason will also be valid during a Packet Command when the DRQ is set. |
| Bit 2 | CORR | Indicates if a Correctable Error occurred. |
| Bit 0 | CHECK | Indicates that an error occurred during execution of the previous command. The bits in the Error Register contains the Sense Key and Code. |

Table 12 - ATAPI Error Register (ATA Error Register)

D7	D6	D5	D4	D3	D2	D1	D0	
Sense Key				MCR	ABRT	EOM	ILI	Read

- | | | |
|----------|-----------|---|
| Bits 7-4 | Sense Key | The sense key is defined in "Table 140 - Sense Key Descriptions" on page 183. |
| Bit 3 | MCR | Media Change Requested, is used and defined as in the ATA Standard. |
| Bit 2 | ABRT | Aborted Command, is used and defined as in the ATA Standard. |
| Bit 1 | EOM | End Of Media Detected. |
| Bit 0 | ILI | Illegal Length Indication. |

Table 13 - ATAPI Feature Register (ATA Feature Register)

D7	D6	D5	D4	D3	D2	D1	D0	
Reserved						OVER-LAP	DMA	Write

- Bit 7-1 Reserved Reserved for future enhancement.
- Bit 0 DMA (Optional) Any data for the Command will be transferred via the DMA interface. Note this does not apply for the Command Packet.
- Bit 1 OVERLAP (Optional) The device may release the ATA bus before this command has completed. Release of the ATA bus is at the discretion of the device.

Table 14 - ATAPI Byte Count Register (ATA Cylinder High/Low Register)

D7	D6	D5	D4	D3	D2	D1	D0	
Byte Count (Bits 0-7)								R/W
Byte Count (Bits (8-15))								R/W

The Byte Count is used for PIO only. The count *shall* be set prior to the issuance of the Packet Command. The count contains the total transfer size for commands that transfer only one group of data (e.g. Mode Sense / Select, Inquiry) For commands that require multiple DRQ Interrupts (e.g. Read, or Write) the count is set to the desired transfer size. When any data is to be transferred, the ATAPI Device will set the Byte Count to the amount of data that the Host *shall* transfer and then issue the DRQ Interrupt. The contents of this register *shall* not be changed until the first word is transferred to/from the data register. Once the data transfer has been started, the device is allowed to change the contents of the byte count (to set up the next transfer).

Table 15 - ATAPI Interrupt Reason Register (ATA Sector Count Register)

D7	D6	D5	D4	D3	D2	D1	D0	
Reserved					RELEASE	IO	CoD	Read

- Bit 0 CoD Command or Data. When this bit is zero then the information being transferred is user data, when one then the data is Command.
- Bit 1 IO Direction for the Information transfer, where in to the Host is indicated by a value of one and out to the device is zero.
- | | | | |
|----|-----|-----|---|
| IO | DRQ | CoD | |
| 0 | 1 | 1 | Command - Ready to Accept Command Packet Bytes |
| 1 | 1 | 1 | Message (Future) - Ready to Send Message data to Host |
| 1 | 1 | 0 | Data To Host- Send command parameter data (e.g. Read Data) to the host |
| 0 | 1 | 0 | Data From Host - Receive command parameter data (e.g. Write Data) from the host |
| 1 | 0 | 1 | Status - Register contains Completion Status |
- Bit 2 RELEASE Release indicates that the device has released the ATA bus before completing the command in progress.

Table 16 - ATAPI Drive Select Register (ATA Drive / Head Select Register)

D7	D6	D5	D4	D3	D2	D1	D0	
1	Reserved	1	DRV	Reserved for SAM LUN				R/W

- Bit 4 DRV This bit selects either Device 0 (DRV=0) or 1 (DRV=1).

Table 17 - ATAPI Device Control Register (ATA Device Control Register)

D7	D6	D5	D4	D3	D2	D1	D0	
Reserved				1	SRST	nIEN	0	Write

- Bit 2 SRST This bit is the Software Reset. The ATAPI Device *shall* follow the reset sequence for SRST defined in "6.3 ATAPI Implementation of ATA SRST" on page 50. There is also a new reset capability for ATAPI Devices utilizing a RESET COMMAND (see "6.2 ATAPI Soft Reset Command and Protocol" on page 50).
- Bit 1 nIEN This bit enables/disables the interrupt to the host. When nIEN=0 and the device is selected, INTRQ *shall* be enabled through a tri-state buffer. When nIEN=1 or the device is not selected, the INTRQ signal *shall* be in a high impedance state

Intentionally Left Blank

7.0 CD-ROM ATA (Task File) Commands

7.1 ATA (Task File) Command Implementation Requirements

This section details the Commands that the CD-ROM Device *shall* support from the ATA Standard definition of the commands. All ATAPI commands, other than the “A0” ATAPI Packet Command, shall use the protocol described in the ATA 948 Document.

Table 18 - ATA Command and Status Usage for ATAPI CD-ROM Devices

Command	used	Code	Error Register						Status Register				
			BBK	UNC	IDNF	ABRT	TKONF	AMNF	DRDY	DWF	DSC	CORR	ERR
Acknowledge Media Change	N	DB				V							V
ATAPI Soft Reset	M	08											
Boot - Post-boot	N	DC				V							V
Boot - Pre-boot	N	DD				V							V
Check Power Mode	M	E5				V			V	V	V		V
Door Lock	N	DE				V							V
Door Unlock	N	DF				V							V
Download Microcode	N	92				V			V	V			V
Media eject	N	ED				V			V		V		V
Execute Drive Diagnostics	M	90	Special Drive Diagnostic Errors						V				V
Format Track	N ¹	50				V							V
Identify Drive	N	EC				V							V
Idle	O	E3				V			V	V	V		V
Idle Immediate	M	E1				V			V	V	V		V
Initialize Drive Parameters	N ¹	91				V							V
NOP	M	00				V			V				V
ATAPI Pkt. Command	M	A0	Contains Packet Command Status						V			V	V
ATAPI Identify Device	M	A1				V			V		V		V
Service	O	A2				V			V				V
Read Buffer	N	E4				V							V
Read DMA (w/retry)	N	C8				V							V
Read DMA (wo/retry)	N	C9				V							V
Read Long (w/retry)	N	22				V							V
Read Long (wo/retry)	N ¹	23				V							V
Read Multiple	N	C4				V							V
Read Sector(s) (w/retry)	N ¹	20				V							V
Read Sector(s) (wo/retry)	N ¹	21				V							V
Read Verify Sector(s) (w/retry)	N ¹	40				V							V
Read Verify Sector(S) (wo/retry)	N ¹	41				V							V
Recalibrate	N	1x				V							V

Table 18 - ATA Command and Status Usage for ATAPI CD-ROM Devices (Continued)

Command	used	Code	Error Register						Status Register				
			BBK	UNC	IDNF	ABRT	TKONF	AMNF	DRDY	DWF	DSC	CORR	ERR
Seek	N	7x				V							V
Set Features	M	EF				V			V	V	V		V
Set Multiple Mode	N	C6				V							V
Sleep	M	E6				V			V	V	V		V
Standby	O	E2				V			V	V	V		V
Standby Immediate	M	E0				V			V	V	V		V
Write Buffer	N	E8				V							V
Write DMA (w/retry)	N	CA				V							V
Write DMA (wo/retry)	N	CB				V							V
Write Long (w/retry)	N ¹	32				V							V
Write Long (wo/retry)	N ¹	33				V							V
Write Multiple	N	C5				V							V
Write Same	N	E9				V							V
Write Sector(s) (w/retry)	N ¹	30				V							V
Write Sector(s) (wo/retry)	N ¹	31				V							V
Write Verify	N	3C				V							V
Invalid Command Code						V			V	V	V		V

V = valid on this command
Y = Used by the CD-ROM ATAPI Drive, as specified by the ATA Standard
N = Not supported by ATAPI CD-ROM Drives
M = Mandatory for ATA
Shaded = Commands utilized by the ATAPI CD-ROM Drive

1. This command is specified as Mandatory for ATA, but *shall* NOT be supported by ATAPI Devices

7.1.1 ATAPI Soft Reset

Note: For performance reasons, a soft reset may not force reading of TOC.
See "6.2 ATAPI Soft Reset Command and Protocol" on page 50

7.1.2 Check Power Mode

This command checks the power mode.

If the drive is in, going to, or recovering from the Standby Mode, the drive *shall* set BSY, set the Sector Count Register to 0x00, Clear BSY, and generate an interrupt.

If the drive is in Idle Mode, the drive *shall* set BSY, set the Sector Count Register to 0xFF, clear BSY, and generate and Interrupt.

7.1.3 Execute Drive Diagnostics

This command *shall* perform the internal diagnostic tests implemented by the drive. The DRV bit is ignored. Both drives, if present, *shall* execute this command. See the ATA Standard (X3T9.2/791D) for more information.

Implementer's Note: *ATAPI device drivers issuing the Execute Diagnostics command will cause all ATA and ATAPI devices to execute a diagnostic command resulting in a device reset. To prevent unwanted resets and or driver compatibility issues, ATAPI drivers should not issue the Execute Diagnostics command. The command is implemented by ATAPI devices for ATA compatibility only.*

7.1.4 Idle Immediate

This command causes the drive to set BSY, enter the Idle Mode, clear BSY, and generate an interrupt. The interrupt is generated even though the drive may not have fully transitioned to Idle Mode.

7.1.5 NOP

This command enables a host which can only perform 16-bit register accesses to check drive status. The drive *shall* respond as it does to an unrecognized command by setting Abort in the Error Register, Error in the Status Register, clearing Busy in the Status Register, and asserting INTRQ.

7.1.6 Packet Command

See section 5.2, "ATAPI PACKET Command", on page 21.

7.1.7 ATAPI Identify Device

The ATAPI IDENTIFY DEVICE command enables the host to receive parameter information from the drive. The parameter words in the buffer have the arrangement and meaning defined in the table below. All reserved bits or words *shall* be zero. Although many of the fields of information returned by the ATAPI Identify Device command are inappropriate for a CD-ROM drive, the fields that *shall* be returned with meaningful information are shown in "Table 19 - Identify Drive, Fields Supported by CD-ROM".

Like all ATAPI commands (A0h, A1h and 08h), this command can be issued, regardless of the state of the DRDY. When the command is issued, the device sets BSY, stores the required parameter information in the sector buffer, sets DRQ, and generates an interrupt.

Implementer's Note: ATAPI devices shall swap bytes for ASCII fields to maintain compatibility with ATA." For example, "This Example" would be written as "hTsiE axpmel."

Table 19 - Identify Drive, Fields Supported by CD-ROM

Word	Bits	Description	Used	Fixed/Variable
0		General Configuration	Mandatory	Fixed
1		Cylinders	No	
2		Reserved	No	
3		Heads	No	
4		Number of unformatted bytes per track - vendor specific	No	
5		Number of unformatted bytes per sector - vendor specific	No	
6		Number of sectors per track	No	
7-9		Reserved	No	
10-19		Serial Number	Optional	Fixed
20		Vendor specific	No	
21		Vendor specific	No	
22		ECC bytes available	No	
23-26		Firmware revision (18 ASCII characters)	Mandatory	Fixed
27-46		Model Number (40 ASCII characters)	Mandatory	
47		Multiple Sector Command, Sector Count	No	
48		Reserved	No	
49		Capabilities: LBA bit <i>shall</i> be supported; DMA, IORDY, Overlap and Standby bits are optional.	Mandatory	
50		Reserved	No	
51		PIO Cycle Timing	Mandatory	Fixed
52		DMA Cycle Timing	Mandatory	Fixed
53	15 - 2 1 0	Reserved Fields in words 64-70 valid Fields in words 54-58 valid	Mandatory	Fixed Fixed Variable
54 - 56		Current Cylinder/Heads/Sectors	No	
57-58		Current Capacity	No	
59		Reserved	No	
60-61		User Addressable Sectors	No	
62	15 - 8 7 - 0	Singleword DMA transfer mode active Single word DMA transfer modes supported	Mandatory	Variable Fixed

Table 19 - Identify Drive, Fields Supported by CD-ROM (Continued)

Word	Bits	Description	Used	Fixed/Variable
63	15 - 8 7 - 0	Multiword DMA Transfer Mode Active Multiword DMA Transfer Modes Supported	Mandatory	Variable Fixed
64	15 - 8 7 - 0	Reserved Advanced PIO Transfer Mode Supported	Mandatory	Fixed
65		Minimum Multiword DMA Transfer Cycle Time Per Word (ns)	Mandatory	Fixed
66		Manufacturer's Recommended Multiword DMA Transfer Cycle Time (ns)	Optional	Fixed
67		Minimum PIO Transfer Cycle Time without Flow Control	Optional	Fixed
68		Minimum PIO Transfer Cycle Time with IORDY Flow Control	Optional	Fixed
69 - 70		Reserved (for advanced PIO support)	No	
71		Typical time (μ s) for release when processing an overlapped command	Optional	Fixed
72		Typical time (μ s) for release after receiving the service command	Optional	Fixed
73		Major Revision Number (0000h or FFFFh Device does not report version.	Optional	Fixed
74		Minor Version Number (0000h or FFFFh Device does not report version.	Optional	Fixed
75 - 127		Reserved	No	
128 - 159		Vendor Unique	No	
160 - 255		Reserved	No	

“Optional” Identify Drive words, which are not supported, *shall* be set to zero.

The ATAPI Identify Device command *shall not* delay the transfer of the Identify Drive data by more than 200 ms after receipt of the command.

7.1.7.1 General Configuration Word (0)

Table 20 - Identify Drive Data - General Configuration (Word 0)

Bit Byte	7/15	6/14	5/13	4/12	3/11	2/10	1/9	0/8
0	Removable	CMD DRQ Type		Reserved			CMD Packet Size	
1	Protocol Type		Reserved	Device Type				

Bits 15-14 Protocol Type

This field indicates the protocol in use by the device.
0Xb = ATA
10b = ATAPI
11b = Reserved

Bit 13 Reserved

This is reserved for future enhancement

Bits 12-8 Device Type

This field indicates the device type.
The peripheral types are described in "Table 40 - Peripheral Device Types" on page 94.

Bit 7 Removable

Indicates that the device has removable media.

Bits 6-5	CMD DRQ Type	This field indicates the command packet DRQ type used by this device. 00b = Microprocessor DRQ: ATAPI devices reporting Microprocessor DRQ assertion <i>shall</i> assert DRQ within 3ms of receiving the A0h ATAPI Packet Command. <i>Implementer's Note: Devices reporting Microprocessor DRQ require the device driver to poll for up to 3ms or accept the granularity of an available timer tick. These issues may result in undesirable system delays when used with multi-threaded OS drivers.</i> 01b = Interrupt DRQ: ATAPI devices reporting Interrupt DRQ assertion <i>shall</i> assert INTRQ in conjunction with the assertion of the command packet DRQ. These devices <i>shall</i> assert DRQ within 10ms of receiving the A0h ATAPI Packet Command. 10b = Accelerated DRQ: ATAPI devices reporting Accelerated DRQ assertion <i>shall</i> assert DRQ within 50us of receiving the A0h ATAPI Packet Command. 11b = Reserved for future use.
Bits 4-2	Reserved	This field is unique for each protocol and is reserved for future use.
Bits 1-0	Command Packet Size	This field indicates the size of the command packets used by this device. 00b = 12 bytes (ALL CD-ROM) 01b = 16 bytes (Reserved for SAM Compliant Devices) 1Xb = Reserved for future use.

7.1.7.2 Serial Number (Words 10 - 19)

This optional field *shall* contain the drive's serial number formatted as left-justified ASCII, padded with spaces (20h). If the field is not supported then it *shall* be filled with spaces.

7.1.7.3 Firmware Revision (Words 23-26)

The contents of this field are vendor-specific, left-justified, and padded with spaces.

7.1.7.4 Model Number (Words 27 - 46)

The contents of this field are vendor-specific, left-justified, and padded with spaces.

7.1.7.5 Capabilities Word (Word 49)

Table 21 - Identify Drive Data - Capabilities Word (49)

Bit Byte	7/15	6/14	5/13	4/12	3/11	2/10	1/9	0/8
0	Vendor Unique							
1	Reserved for Interleaved DMA Supported	Reserved for Proxy Interrupt Supported	Overlap Operation Supported (Optional)	Reserved	IORDY Supported (Optional)	IORDY can be disabled (Optional)	LBA Supported (Mandatory)	DMA Supported (Optional)

- Bit 8 DMA Supported This bit indicates that the Device supports the DMA mode of data transfer.

- Bit 9 LBA Supported Indicates that the Device supports the LBA form of addressing. The ATAPI Devices *shall* set this bit to one.

- Bit 10 IORDY can be disabled Is used to indicate a device's ability to enable or disable the use of IORDY. If this bit is set to one, then the device supports the disabling of IORDY.

- Bit 11 IORDY Supported This is used to help determine whether a device supports IORDY. If this bit is set to one, then the device supports IORDY operation. If this bit is zero then the device may support IORDY (this ensures backward compatibility.)

- Bit 13 Overlap Operation Supported This device supports overlapped operations. Both the Release and Service protocol must be supported to report that the Device supports Overlap Operation.

- Bit 14 Reserved for Proxy Interrupt This device supports a shared interrupt technique. This bit is currently reserved for the Proxy Interrupt technique that may be defined in the future.

- Bit 15 Reserved for Interleaved DMA This device will release BSY after transferring DMA data when DMA is used for an overlapped command This bit is currently reserved for an interleaved DMA capability that may be defined in the future.

7.1.7.6 PIO Data Transfer Cycle Timing (Word 51)

The PIO transfer timing for each ATA device falls into categories which have unique parametric timing specifications. To determine the proper device timing category, compare the contents of this field with the Cycle Time specified in Figure 6 of the ATA document in Appendix B. The value returned in Bits 15-8 *shall* fall into one of the categories specified, and if it does not, then Mode 0 *shall* be used to serve as the default timing.

7.1.7.7 DMA Data Transfer Cycle Timing (Word 52)

The DMA transfer timing for each ATA device falls into categories which have unique parametric timing specifications. To determine the proper device timing category, compare the contents of this field with the Cycle Time specified in Figures 8 and 9 of the ATA document in Appendix B. The value returned in Bits 15-8 *shall* fall into one of the categories specified, and if it does not, then Mode 0 *shall* be used to serve as the default timing.

7.1.7.8 Field Validity (Word 53)

Bit 0 When = 1, this bit guarantees that the fields contained in words 54-58 are valid.

Bit 1 When = 1, this bit guarantees that the fields contained in words 64-70 are valid.

7.1.7.9 Single Word DMA Transfer (Word 62)

The low order byte identifies by bit all of the modes which are supported, e.g., if Mode 0 is supported, bit 0 is set. The high order byte contains a single bit set to indicate which mode is active, e.g., if Word 0 is active, bit8 is set.

7.1.7.10 Multi Word DMA Transfer (Word 63)

The low order byte identifies by bit all of the modes which are supported, e.g., if Mode 0 is supported, bit 0 is set. The high order byte contains a single bit set to indicate which mode is active, e.g., if Word 0 is active, bit8 is set.

7.1.7.11 Enhanced PIO Mode (Word 64)

Bits 7 through 0 of the word 64 of the Identify Drive parameter information is defined as the Advanced PIO Data Transfer Supported Field. This field is bit significant. Any number of bits may be set in this field by the device to indicate which Advanced PIO Modes that it is capable of supporting. Of these bits, bits 7 through 1 are reserved for future advanced PIO modes. Bit 0, if set, indicates that the device supports PIO Mode 3.

7.1.7.12 Minimum Multi-word DMA Transfer Cycle Time per Word (Word 65)

Word 65 of the parameter information of the IDENTIFY DRIVE command is defined as the Minimum Multi-word DMA Transfer Cycle Time Per Word. This field defines, in nanoseconds, the minimum cycle time that the device can support when performing Multi-word DMA transfers on a per word basis.

Any device which supports Multi-word DMA Mode 1 or above *shall* support this field, and the value in word 65 *shall* not be less than 150.

If the device does not support this field, the device *shall* return a value of zero in this field.

7.1.7.13 Manufacturer's Recommended Multi-word DMA Transfer Cycle Time (Word 66)

Word 66 of the parameter information of the IDENTIFY DRIVE command is defined as the Manufacturer's Recommended Multi-word DMA Transfer Cycle Time. This field defines, in nanoseconds, the minimum cycle time per word during a single sector host transfer while performing a multiple sector READ DMA or WRITE DMA commands over all locations on the media under nominal conditions. A cycle time less than this value may cause DMARQ to be deasserted at a rate which may reduce throughput without data corruption.

Any device which supports Multi-word DMA Mode 1 or above *shall* support this field, and the value in word 66 *shall not* be less than the value in word 65.

If the device does not support this field, the device *shall* return a value of zero in this field.

7.1.7.14 Minimum PIO Transfer Cycle Time Without Flow Control (Word 67)

Word 67 of the parameter information of the IDENTIFY DRIVE command is defined as the Minimum PIO Transfer Without FLOW Control Cycle Time. This field defines, in nanoseconds, the minimum cycle time that, if used by the host, the device guarantees data integrity during the transfer without utilization of flow control.

Any device which supports PIO Mode 3 or above *shall* support this field, and the value in word 67 *shall not* be less than 180.

If the device does not support this field, the device *shall* return a value of zero in this field.

7.1.7.15 Minimum PIO Transfer Cycle Time with IORDY Flow Control (Word 68)

Word 68 of the parameter information of the IDENTIFY DRIVE command is defined as the Minimum PIO Transfer With IORDY Flow Control Cycle Time. This field defines, in nanoseconds, the minimum cycle time that the device can support while performing data transfers while utilizing IORDY flow control.

Any device which supports PIO Mode 3 or above *shall* support this field, and the value in word 68 *shall* not be less than 180. If the device does not support this field, the device *shall* return a value of zero in this field.

7.1.7.16 Typical Time for the Release After Command Received (Word 71)

Devices reporting support for overlapped operations shall report the typical (3sigma) time in microseconds that the device takes to release the bus after receipt of any A0 packet command. Note that for performance reasons a device may choose not to release the bus. Host systems may assume that the device has chosen not to release the bus after waiting three times the typical time reported in this word (See "5.17.1 Release" on page 40).

7.1.7.17 Typical Time for the Clearing of Busy After SERVICE Command (Word 72)

Devices reporting support for overlapped operations shall report the typical (3 sigma) time in microseconds that the device takes to clear Busy after receipt of a Service command (See "5.17.1 Release" on page 40).

7.1.7.18 Major Version Number (Word 73)

If not 0000h or FFFFh, the device claims compliance with the major version(s) as indicated by bits 1 through 2 being equal to one (ATAPI 1.x and 2.x). Values other than 0000h and FFFFh are bit significant.

7.1.7.19 Minor Version Number (Word 74)

If an implementor claims that the revision of the specification they used to guide their implementation does not need to be reported or if the implementation was based upon a specification prior to this revision of the standard, word 73 shall be 0000h or FFFFh. Reported value for this compliance with this specification shall be 9h.

7.1.8 Service

The Service command is used to restore the task file of a device which has released the ATA bus while processing an overlapped command. Unlike all other commands, a device processing an overlapped command which has its service bit set shall not abort the command in progress. Upon completion of the Service command the device's task file shall reflect the correct status of the overlapped command.

Upon receipt of the Service command the device *shall* clear the SERVICE bit before it de-asserts BSY (See "7.1.8 Service" on page 68).

Completion of the Service Command is different than all other commands. It occurs when the state of the "Task File" registers has been restored to the state they would be in if no release had occurred. In this case, the Busy bit *shall* be cleared.

7.1.9 Set Features

The Set Features command is used to set some interface timing and protocol modes. These modes are set at Post by many BIOSes. The contents of the ATAPI Features Register indicates the function to be performed.

Table 22 - Contents of the Feature Register for Set Features Command

Bit Byte	7	6	5	4	3	2	1	0
0	Set (1)/ Clear (0) Feature	Feature Number						

Table 23 - Set Feature Register Definitions

Register Contents	Set Feature Commands	Support
01h	Enable 8-bit data transfers	No
02h	Enable write cache	No
03h	Set transfer mode based on value in sector count register	Mandatory
33h	Disable retry	No
44h	Vendor unique length of ECC on read long/write long commands	No
54h	Set cache segments to sector count register value	No
5Dh	Enable Interrupt for Release after the receipt of an Overlapped Command	Mandatory ¹
5Eh	Enable Interrupt after the completion of A2h Service Command	Mandatory ²
55h	Disable read look-ahead feature	No
66h	Disable reverting to power on defaults	Mandatory
77h	Disable ECC	No
81h	Disable 8-bit data transfers	No
82h	Disable write cache	No
88h	Enable ECC	No
99h	Enable retries	No
AAh	Enable read look-ahead feature	No
ABh	Set maximum prefetch using sector count register value	No

Table 23 - Set Feature Register Definitions (Continued)

Register Contents	Set Feature Commands	Support
BBh	4 bytes of ECC apply on read long/write long commands	No
CCh	Enable reverting to power on defaults	Mandatory ¹
DDh	Disable Interrupt for Release after the receipt of an Overlapped Command	Mandatory ¹
DEh	Disable Interrupt after the Completion of A2h Service Command	Mandatory ²

1. Mandatory if the device reports more than 50 μ s in word 71 of the identify drive data and supports Overlap.
2. Mandatory if the device reports more than 50 μ s in word 72 of the identify drive data and supports Overlap.

If the value in the register is not supported or is invalid, the drive posts an Aborted Command error.

At power on, or after a hardware reset, the default mode is the same as that represented by values greater than 80h.

7.1.9.1 Set Transfer Mode (03h)

A host can choose the transfer mechanism by Set Transfer Mode and specifying a value in the Sector Count Register. The upper 5 bits define the type of transfer and the low order 3 bits encode the mode value. Since both PIO and DMA settings can be active simultaneously, the Device *shall* maintain independent transfer mode settings for both PIO and DMA.

Table 24 - Feature Number Description for Set Feature Command

Feature Number		Default Setting	
03h	Data Transfer Mode. Mode contained in Sector Count Register.		PIO & DMA Mode 0
	Value in Sector Count Register	Definition	
	00000 00x	PIO Default Transfer Mode	
	00001 xxx	PIO Flow Control Transfer mode x	
	00010 xxx	Single Word DMA mode x	
	00100 xxx	Multi-word DMA	
	00011 xxx	Reserved (For Pseudo DMA mode)	

If a device which supports this specification receives a Set Feature command with a Set Transfer Mode parameter and a Sector count Register value of 00000 000, it *shall* set its default PIO transfer mode.

If a device which supports this specification receives a Set Feature command with a Set Transfer Mode parameter and a Sector Count Register value of 00000 001 and the device supports disabling of IORDY, then the device *shall* set its default PIO transfer mode and disable IORDY.

7.1.9.2 Enable Interrupt for Release after receipt of Command Packet (5Dh)

A setting of 5Dh will cause the device to issue an interrupt when the device has released the bus to the host.

7.1.9.3 Enable Interrupt After Completion of Service Command (5Eh)

A setting of 5Eh will cause the device to issue an interrupt when the device has finished processing the Service command (clearing Busy).

7.1.9.4 Disable Reverting to Power On Defaults (66h)

A setting of 66h allows settings of greater than 80h which may have been modified since power on to remain at the same setting after a software reset. At power on, or after a hardware reset, the default mode is the same as that represented by values greater than 80h.

7.1.9.5 Enable Reverting to Power On Defaults (CCh)

A setting of CCh will cause the Device to revert back to the default for settings of greater than 80h, which may have been modified since power on, after a software reset.

7.1.9.6 Disable Interrupt for Release after receipt of Command Packet (DDh)

A setting of DDh will cause the device not to issue an interrupt when the device has released the bus to the host.

7.1.9.7 Disable Interrupt After Completion of Service Command (DEh)

A setting DEh will cause the device not to issue an interrupt when the device has finished processing the Service command (clearing Busy).

7.1.10 Sleep

This command is the only way to cause the drive to enter Sleep Mode. The drive is spun down, and when it is stopped, BSY is cleared, an interrupt is generated, and the interface becomes inactive.

The only way to recover from Sleep mode is with a software reset or a hardware reset.

NOTE: The use of hardware reset to recover from Sleep mode may be incompatible with continued operation of the host system.

A drive *shall* not power on in Sleep Mode nor remain in Sleep Mode following a reset sequence. If the drive is already spun down, the spin down sequence is not executed.

7.1.11 Standby Immediate

This command causes the drive to enter the Standby Mode. The drive may return the interrupt before the transition to Standby Mode is completed.

If the drive has already spun down, the spin down sequence is not executed.

For Standby immediate the drive may return the interrupt before the transition to Standby Mode is completed.

For Sleep, the drive may return the interrupt before the transition to Sleep Mode is completed.

8.0 CD-ROM Model

CD-ROM devices permit reading data from a rotating media. Writing the media is not currently supported, but will be in the future (CD-WO and CD-MO). Data transfer can begin with any of the consecutively numbered logical blocks. Data on CD-ROM devices is addressed the same as for (magnetic) direct-access devices. Some CD-ROM devices support a separate information stream (e.g. audio and/or video but referred to as audio in this Section) transmitted via a connection other than the AT Bus. This specification defines commands for controlling these other information streams for CD-ROM devices.

CD-ROM drives are designed to work with any disc that meets IEC. Many new drives read CD-ROM data discs, digital audio discs, and audio-combined discs (i.e. some tracks are audio, some tracks are data).

8.1 New Capabilities Since the SCSI-2 Standardization

Unfortunately, the introduction of Photo CDs (with multiple sessions), CD-ROM XA Format (two different format modes), and CD-I has occurred after the standardization effort. In addition, the SCSI standard did not provide a method to return the CD-DA data. As is characteristic with “new” functionality, each vendor has devised their own solutions. This ATAPI Proposal has taken the “Common Command Set (CCS)” approach to the problem and created a minimal mandatory command set that includes capabilities that are currently addressed by the DRAFT SCSI-3 Multi-media Command standard (MMC).

8.2 CD-ROM Media Organization

The formats written on the CD-ROM and CD-DA (Digital Audio) media require special interfacing considerations.

NOTE This subsection contains a number of terms that have special meanings peculiar to CD-ROM technology or that may be unfamiliar to many readers of this Specification. The glossary defines these terms.

Discs may contain either audio, data or a mixture of the two. "Table 25 - Example Mixed Mode CD-ROM Disc Layout" on page 72 gives an example of an audio-combined disc to illustrate the relationship between the logical block addresses reported and the MSF address encoded on the media.

NOTE: The term “frame” is used in two different ways in the CD-ROM media standard. The intended meaning can only be determined from the context. Whenever possible, this description replaces the larger data unit with the more familiar term sector. The primary exception to this policy is the use of frame when referring to the MSF address. In the MSF context, one frame (F field unit) equals one sector. On a typical two channel CD-DA media, each frame (F field unit) is played in 1/75th of a second.

Table 25 - Example Mixed Mode CD-ROM Disc Layout

Block Description	Logical Address (Decimal)	Absolute MSF Address ¹	Track and Index	Sector is Info or is Pause	Mode Audio or Data	CD-ROM Data Mode ²
Lead-in area ³	---	---	0/-	---	Audio	---
Pre-gap ³	---	00/00/00	1/0	Pause	Data	Null
1st track data	0000 ⁴	00/02/00 ⁵	1/1	Info	Data	L-EC
2nd track data	6000 ⁴	01/16/00 ⁵	2/1	Info	Data	L-EC
	7500	01/2A/00	2/2	Info	Data	L-EC
Post-gap	9000	02/02/00	2/3	Pause	Data	Null
Pause-silence	9150	02/04/00	3/0	Pause	Audio	---
3rd track audio	9300 ⁶	02/04/00 ⁷	3/1	Info	Audio	---
	1400	02/22/00	3/2	Info	Audio	---
4th track audio	21975 ⁶	04/35/00 ⁷	4/1	Info	Audio	---
Pre-gap part 1	30000	06/28/00	5/0	Pause	Audio	---
Pre-gap part 2	30075	06/29/00	5/0	Pause	Data	Null
5th track data	30225	06/2B/00	5/1	Info	Data	L-EC
Last information	263999 ⁸	3A/27/4A	5/1	Info	Data	L-EC
Post-gap	---	3A/28/00	5/2	Pause	Data	Null
Lead-out track	264000 ⁹	58/42/00 ¹⁰	AA/ ¹¹	Pause	Audio	---

1. Absolute MSF address repeated in the header field of data blocks.
2. The CD-ROM data mode is stored in the header of data tracks. This indicates that the block is part of a data pre-gap or post-gap (null), that this is a data block using the auxiliary field for L-EC symbols (ECC - CD-ROM data mode one), or that this is a data block using the auxiliary field for user data (CD-ROM data mode two).
3. Table of contents information is stored in the sub-channel of lead-in area. The lead-in area is coded as track zero. Track zero and the initial 150 sector pre-gap (or audio pause) are not accessible with logical addressing.
4. Exact value returned by READ TOC command.
5. Value stored in table of contents with zero tolerance.
6. Value returned by READ TOC command plus or minus 75 blocks.
7. Value stored in table of contents plus or minus 75 sectors.
8. Minimum value returned by READ CD-ROM CAPACITY; exact value depends on encoding of this track and the lead out track and whether this is derived from the TOC data.
9. Value returned by READ TOC command; exact, if lead-out track is encoded as data, or plus or minus 75 blocks if encoded as audio.
10. Value stored in table of contents; exact, if lead-out track is coded as data, or plus or minus 75 blocks if coded as audio.
11. Lead-out track number is defined as 0AAh.

The physical format defined by the CD-ROM media standards provides 2352 bytes per sector. For usual computer data applications, 2048 bytes are used for user data, 12 bytes for a synchronization field, 4 bytes for a sector address tag field and 288 bytes - the auxiliary field - for L-EC (CD-ROM data mode 1). In less critical applications, the auxiliary field may also be used for user data (CD-ROM data Mode 2 / Form 2).

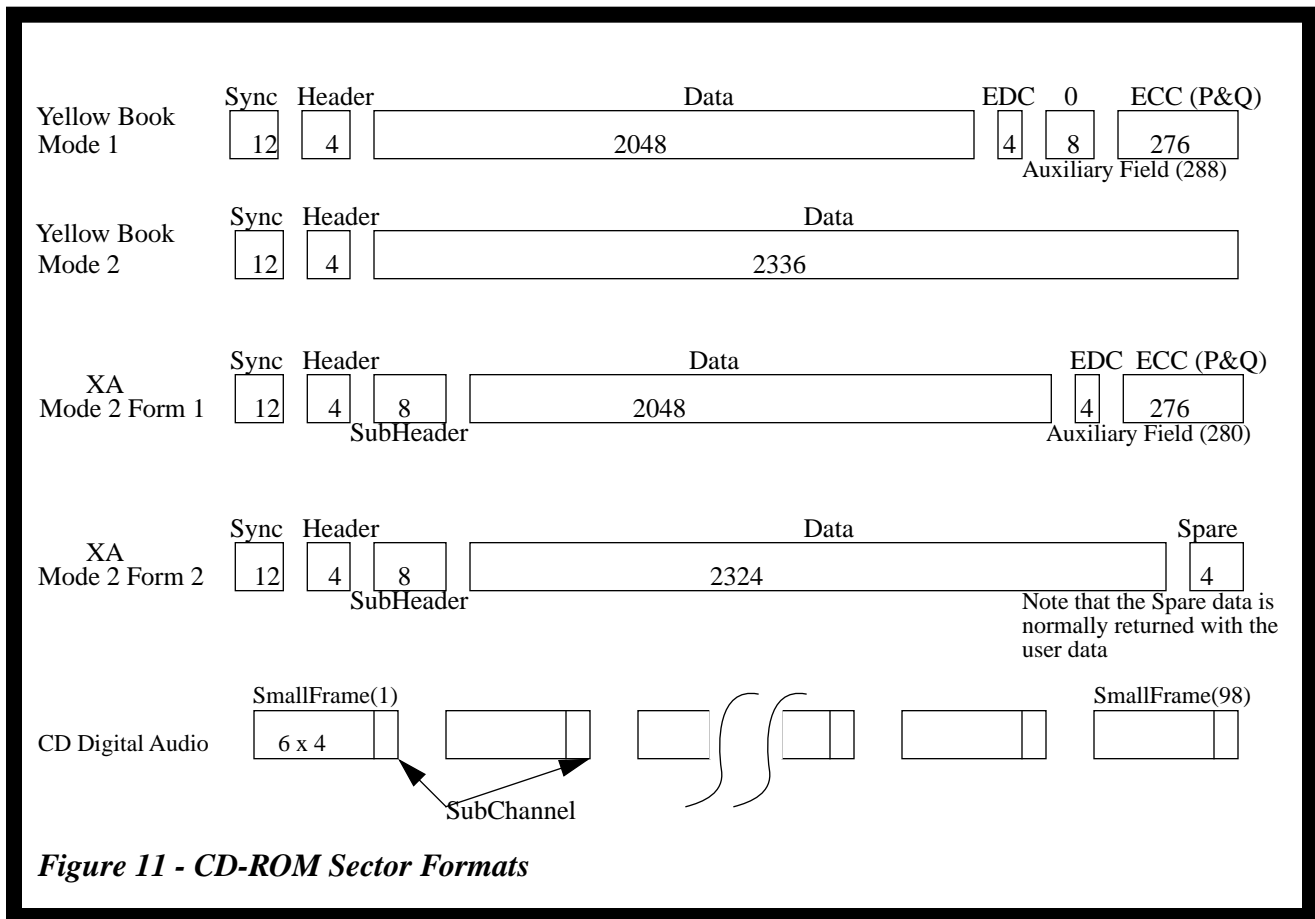

A CD-ROM physical sector size is 2048, 2052, 2056, 2324, 2332, 2336, 2340 or 2352 bytes per sector. These values correspond to the user data plus various configurations of header, subheader and EDC/ECC.

This same area of the CD-ROM or CD audio media may store 1/75th of a second of two channel audio information formatted according to the CD-DA specification. (These audio channels are usually the left and right components of a stereo pair.) An audio only density code value can be used to declare an area of the media to be invalid for data operations.

For data and mixed mode media (those conforming to ISO/IEC 10149), logical block address **ZERO** *shall* be assigned to the block at MSF address 00/02/00. For audio media (those conforming only to IEC 908), logical block address **ZERO** *shall* be assigned to the actual starting address of track 1. This may be approximated by using the starting address of track 1 contained in the table of contents (TOC) or by assigning logical block address **ZERO** to the block at MSF address 00/02/00.

Logical addressing of CD-ROM information may use any logical block length. When the specified logical block length is an exact divisor or integral multiple of the selected number of bytes per CD-ROM sector, the device *shall* map (one to one) the bytes transferred from CD-ROM sectors to the bytes of logical blocks. For instance, if 2048 bytes are transferred from each CD-ROM sector (specified by the CD-ROM density code value), and the logical block length is 512 bytes, then each CD-ROM sector *shall* map to exactly four logical blocks. This Specification does not define the mapping of logical block lengths which do not evenly divide or are not exact multiples of the selected number of bytes per CD-ROM sector.

A track may be viewed as a partition of the CD-ROM address space. A CD-ROM media contains from one to ninety-nine tracks. All information sectors of a track are required to be of the same type (audio or data) and mode. Each change in the type of information on the disc requires a change in track number. A disc containing both audio and data would have at least two tracks, one for audio and one for data.

The tracks of a CD media are numbered consecutively with values between 1 and 99. However, the first information track may have a number greater than 1. Tracks have a minimum length of 300 sectors including any transition area that is part of a track.

The CD-ROM media standards require transition areas between tracks encoded with different types of information. In addition, transition areas may be used at the beginning or end of any track. For audio tracks the transition areas are called pause areas. For data tracks, transition areas are called pre-gap and post-gap areas. See "*Table 25 - Example Mixed Mode CD-ROM Disc Layout*" on page 72 for an example. The IEC 908 and ISO/IEC 10149 standards specify minimum time durations for these areas. Maximum time durations are not specified.

Transition areas are formatted and the logical address continues to increment through transition areas. Some media (i.e. discs with only one track) may not have transition areas. The means to determine the location of the transition areas is vendor or application-specific and is addressed by other standards (e.g. ISO 9660).

CD-ROM is a unique device in the respect that some logical blocks on a disc may not be accessible by all commands. SEEK commands may be issued to any logical block address within the reported capacity of the disc. READ commands cannot be issued to logical blocks that occur in some transition areas, or to logical blocks within an audio track. PLAY commands cannot be issued to logical blocks within a data track.

CD-ROM media have lead-in and lead-out areas. These areas are outside of the user-accessible area as reported in the READ CD-ROM CAPACITY data. The lead-in area of the media is designated track zero. The lead-out area is designated track 0AAh. The sub-channel Q in the lead-in track contains a table of contents (TOC) of the disc.

NOTE: The READ CD-ROM CAPACITY command returns the logical block address of the last block prior to the lead-out area. This location may be in a transition area and therefore not a valid address for read operations.

The table of contents gives the absolute MSF location of the first information sector of each track. Control information (audio/data, method of audio encoding, etc.) for each track is also given in the TOC. However, the TOC does not distinguish between the different modes of data tracks (i.e. CD-ROM Data Mode 1 vs. CD-ROM Data Mode 2).

The MSF locations of the beginning of data tracks in the TOC are required to be accurate; however, the TOC values for audio tracks have a tolerance of plus or minus 75 sectors. Information from the TOC can be used to reply to a READ CD-ROM CAPACITY command. When this is done, the drive implementor *shall* consider the possible tolerances and return a value that allows access to all information sectors.

An index is a partition of a track. Pre-gap areas are encoded with an index value of zero. Pause areas at the beginning of audio tracks are also encoded with an index value of zero. The first information sector of a track has an index value of one. Consecutive values up to 99 are permitted. Index information is not contained in the TOC. Not all sectors are encoded with the index value in the Q-sub-channel data (the requirement is 9 out of 10). A sector without an index value is presumed to have the same index as the preceding sector.

Tracks and indexes are not defined to be any particular length, (except for a minimum track length of 300 sectors.) A CD disc may be created with a single information track that has a single index; or with 99 information tracks, each with 99 indexes.

The sub-channel information which is part of each sector includes a track relative MSF location value giving the distance from the first information sector of the track. On the media, this value decreases during the pre-gap area (sectors with index values of 0) and increases for the rest of the track. The data, returned by the READ SUB-CHANNEL command with MSF bit set to zero, converts this to a track relative logical block address (TRLBA). The TRLBA is continual-

ly increasing over the whole track, and pre-gap areas *shall* return negative values. When the MSF bit in the read sub-channel command is set to one, the MSF track relative location value from the media is reported without change.

Note: The purpose of accessing MSF addresses less than 00M 02S 00F is to retrieve information, such as packet size, from incrementally written discs. This information exists in the track descriptor block in the pre-gap area. Users can read this information by scanning the area between 00M 01S 00F to 00M 02S 00F. While the media may contain multiple redundant copies of the pre-gap data, the device *shall* only return one copy. The drive may not be able to read 00M 00S 00F since there is no Sub-Q information before this frame. Refer to CD-ROM Orange book for additional details.

8.3 CD-ROM Physical Data Format

The physical format of CD-ROM and CD-DA media uses a smaller unit of synchronization than the more familiar magnetic or optical recording systems. The basic data stream synchronization unit is a small frame. This is not the same large frame (sector) as referred to in the MSF unit. Each small frame consists of 588 bits. A sector on CD-ROM media consists of 98 small frames.

A CD-ROM small frame consists of:

1. 1 synchronization pattern (24+3 bits)
2. 1 byte of sub-channel data (14+3 bits)
3. 24 bytes of data (24 x (14+3) bits)
4. 8 bytes of CIRC code (8 x (14+3) bits) Total: 588 bits.

Data, sub-channel and CIRC bytes are encoded with an 8-bit to 14-bit code; then three merging bits are added. The merging bits are chosen to provide minimum low-frequency signal content and optimize phase lock loop performance.

8.3.1 Frame Format for Audio

Each small frame of an audio track on a two-channel CD-DA or CD-ROM media consists of six digitized 16-bit samples of each audio channel. These 24 bytes of data are combined with a synchronization pattern, CIRC bytes and a sub-channel byte to make a frame. Each frame takes approximately 136.05 μ s to play. This gives a sampling rate of 44.1 kHz for each channel. The sub-channel information creates the higher level sector grouping for audio tracks.

8.3.2 Sector Format for Data

The data bytes of 98 small frames comprise the physical unit of data referred to as a sector. (98 small frames times 24 bytes per small frame equals 2352 bytes of data per sector.)

A sector that contains CD-ROM Data Mode 1 data has the following format:

1. 12-byte synchronization field
2. 4-byte CD-ROM data header
 - Absolute M field
 - Absolute S field
 - Absolute F field
 - CD-ROM data mode field
3. 2048-byte user data field

4. 4-byte error detection code
5. 8 bytes zero
6. 276-byte layered error correction code

A sector that contains CD-ROM Data Mode 2 data has the following format:

1. 12-byte synchronization field
2. 4-byte CD-ROM data header
 - Absolute M field
 - Absolute S field
 - Absolute F field
 - CD-ROM data mode field
3. 2336-byte user data field (2048 bytes of mode 1 data plus 288 bytes of auxiliary data)

NOTE Many drives are capable of returning CD-ROM data mode one data in a CD-ROM data mode two format. This allows the user to investigate the error detection and error correction codes. However data encoded as CD-ROM data mode two cannot be read as CD-ROM data mode one data.

8.3.3 Sub-channel Information Formats

The sub-channel byte of each frame is assigned one bit for each of the 8 sub-channels, designated P, Q, R, S, T, U, V, W.

Sub-channel P is a simple flag bit that may be used for audio muting control and track boundary determination.

Sub-channel Q has a higher level of structure. All the sub-channel Q bits of a sector define the sub-channel Q information block. (For audio tracks, decoding the Q sub-channel is the only way to distinguish sector boundaries.)

The sub-channel Q block consists of 98 bits, one bit from each small frame in a sector. Three formats are defined for the sub-channel Q information block. The first format provides location information and is defined as follows:

1. 2-bit sub-channel synchronization field
2. 4-bit ADR field (defines the format)
3. 4-bit control field (defines the type of information in this sector)
4. 8-bit track number
5. 8-bit index number
6. 24-bit track relative MSF address
7. 8 bits Reserved (0)
8. 24-bit Absolute MSF address
9. 16-bit CRC error detection code

This format is required to exist in at least nine out of ten consecutive sectors.

The second and third formats are optional. If used, they *shall* exist in at least one out of 100 consecutive sectors. They include the absolute frame byte of the MSF address to provide location information continuity.

The second format gives the catalogue number of the disc (UPC/EAN bar code number). This information is constant over the whole media.

The third format gives the International Standard Recording Code (ISRC) for each track. The ISRC is defined in ISO 3901. This format is not present on lead-in or lead-out tracks and may change only after the track number changes.

8.4 CD Audio Error Reporting

PLAY AUDIO commands with the immediate bit set in the audio control mode return status as soon as the command has been validated (which may involve a seek to the starting address). The playback operation continues and may complete without notification to the Host Computer. Error termination of audio operations *shall* be reported to the Host Computer by returning immediate CHECK CONDITION status to the next command (except for REQUEST SENSE and INQUIRY.) The deferred error sense data is used to indicate that the error is not due to the current command.

The status of the play operation may be determined by issuing a REQUEST SENSE command. The sense key is set to NO SENSE and the audio status is reported in the additional sense code qualifier field.

8.5 CD-ROM Ready Condition/Not Ready Condition

The ready condition occurs after a cartridge is inserted and the drive has performed its initialization tasks. These may include reading the table of contents from the media. This “Ready” is different from and *shall* not be confused with the ATA Ready Status. A check condition status will be returned for the not ready condition only for commands that require or imply a disc access.

A not ready condition may occur for the following reasons:

1. There is no cartridge inserted.
2. The drive is unable to load or unload the cartridge.
3. The drive is unable to recover the table of contents.

The drive *shall* spin up and make the disc ready for media accesses when a new disc is detected.

Any media access that occurs when the drive is not spinning *shall* spin the drive up and not generate an error.

8.5.1 Packet Command Not Ready Status Utilization

Table 26 - Not Ready Error Reporting (by Command)

Command	Opcode	May Return Not Ready Error
INQUIRY	12h	No
LOAD / UNLOAD CD	A6h	Yes
MECHANISM STATUS	BDh	No
MODE SELECT(10)	55h	No
MODE SENSE(10)	5Ah	No
PAUSE/RESUME	4Bh	Yes
PLAY AUDIO	45h	Yes
PLAY AUDIO MSF	47h	Yes
PLAY CD	BCh	Yes
PREVENT/ALLOW MEDIUM REMOVAL	1Eh	See Actions for Lock / Unlock / Eject on page 136 for Actions allowed
READ(10)	28h	Yes
READ(12)	A8h	Yes
READ CD-ROM CAPACITY	25h	Yes
READ CD	BEh	Yes
READ CD MSF	B9h	Yes
READ HEADER	44h	Yes
READ SUB-CHANNEL	42h	Yes
READ TOC	43h	Yes
REQUEST SENSE	03h	No
SCAN	BAh	Yes
SEEK	2Bh	Yes
SET CD SPEED	BBh	No
STOP PLAY / SCAN	4Eh	Yes
START STOP UNIT	1Bh	Yes
TEST UNIT READY	00h	Yes

8.6 CD-ROM Address Reporting Formats (MSF bit)

Several CD-ROM specific commands can return addresses either in logical or in MSF format. The READ HEADER, READ SUB-CHANNEL and READ TABLE OF CONTENTS commands have this feature.

Table 27 - MSF Address Format

Bit Byte	7	6	5	4	3	2	1	0
0	Reserved							
1	M Field							
2	S Field							
3	F Field							

An MSF bit of zero requests that the logical block address format be used for the CD-ROM absolute address field or for the offset from the beginning of the current track expressed as a number of logical blocks in a CD-ROM track relative address field.

An MSF bit of one requests that the MSF format be used for these fields. In certain transition areas, the relative MSF addresses are decreasing positive values. The absolute MSF addresses are always increasing positive values. The M, S, and F fields are expressed as binary numbers. Sensing Support for CD-Audio Commands

If any commands related to audio operations are implemented, then all the AUDIO commands *shall* be implemented. To allow a method for the Host Computer to determine if audio operations are supported, an ATAPI CD-ROM Drive responding to a PLAY AUDIO command which has a transfer length of zero, with CHECK CONDITION status, and setting the sense key to ILLEGAL REQUEST does not support audio operations.

8.7 Error Reporting

If any of the following conditions occur during the execution of a command, the ATAPI CD-ROM Drive *shall* return CHECK CONDITION status. The appropriate sense key and additional sense code *shall* be set. The following list illustrates some error conditions and the applicable sense keys. The list does not provide an exhaustive enumeration of all conditions that may cause the CHECK CONDITION status.

Table 28 - Error Conditions and Sense Keys

Condition	Sense Key
Invalid logical block address	ILLEGAL REQUEST
Unsupported option requested	ILLEGAL REQUEST
Attempt to read a blank block	ILLEGAL REQUEST
Attempt to play a data block as audio	ILLEGAL REQUEST
ATAPI CD-ROM Drive reset or medium change since last command	UNIT ATTENTION
Self diagnostic failed	HARDWARE ERROR
Unrecovered read error	MEDIUM ERROR / HARDWARE ERROR
Recovered read error	RECOVERED ERROR
Overrun or other error that might be resolved by repeating the command	ABORTED COMMAND

In the case of an invalid logical block address, the sense data information field *shall* be set to the logical block address of the first invalid address.

In the case of an attempt to read a blank or previously unwritten block, the sense data information field *shall* be set to the logical block address of the first blank block encountered. The data read up to that block *shall* be transferred.

There are other special error situations for CD-ROM devices. In the following cases the sense key *shall* be set to ILLEGAL REQUEST and the additional sense code set to END OF USER AREA ENCOUNTERED ON THIS TRACK:

1. a post-gap area is encountered (i.e. a block with CD-ROM Data Mode 0);
2. a pre-gap area is encountered (i.e. a block with index equal to 0);
3. The information type (Data Mode vs. Audio etc.) changes.

When not performing audio playback, if the logical block address requested is not within a data track, the command *shall* be terminated with CHECK CONDITION status. The sense key *shall* be set to ILLEGAL REQUEST and the additional sense code set to ILLEGAL MODE FOR THIS TRACK. This applies to audio-combined and audio media.

Intentionally Left Blank

9.0 Changer Model

A changer device will perform exactly like a single ATAPI CD-ROM drive. However it will support two (2) new commands, MECHANISM STATUS (BDh) and LOAD/UNLOAD CD (A6h).

A changer device provides a storage area for more than one CD Disc. This storage area contains multiple areas called slots. Each slot can contain just one Disc. Once a Disc has been placed in to a given slot, it becomes locked in that position. This specification provides no capability to move a Disc from one slot to another. Thus when a Disc has been moved from a given slot into the playing position, it can only be moved back into the slot that it came from. This *shall* be followed even if power is lost while a Disc is in the playing position or while it was being moved.

There are two basic types of changer mechanisms, one that has individually addressable eject and load capability and another that uses a cartridge to hold the discs. In the former, individual disc can be changed, while in the later all the stored discs must be changed at one time.

Any time a Disc/Cartridge is removed or installed from the changer, the device *shall* generate an Unit Attention Condition. After the host detects the unit attention on a known changer device, the host may issue a MECHANISM STATUS Command. This will provide the host with information on what disc is present or was changed.

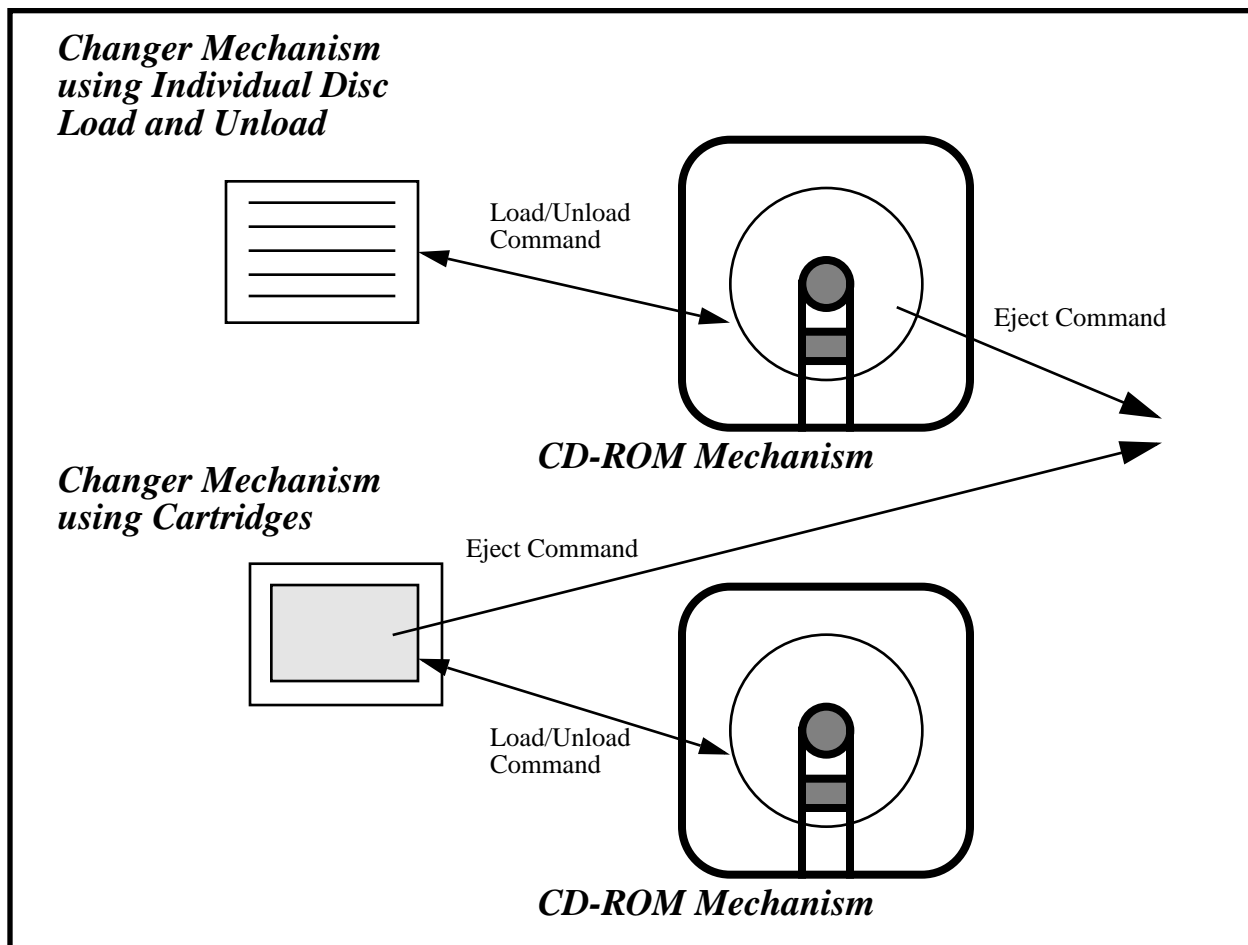

9.1 Initialization

The Changer *shall* perform it's initialization routine at power on or receipt of a hardware reset from the host.

"Initializing Changer" is a process that refers to gathering the information that is necessary to respond to the MECHANISM STATUS Command. If a changer is in the process of Initializing when it receives a MECHANISM STATUS Command, it will respond immediately and provide no slot table information (Only the Header).

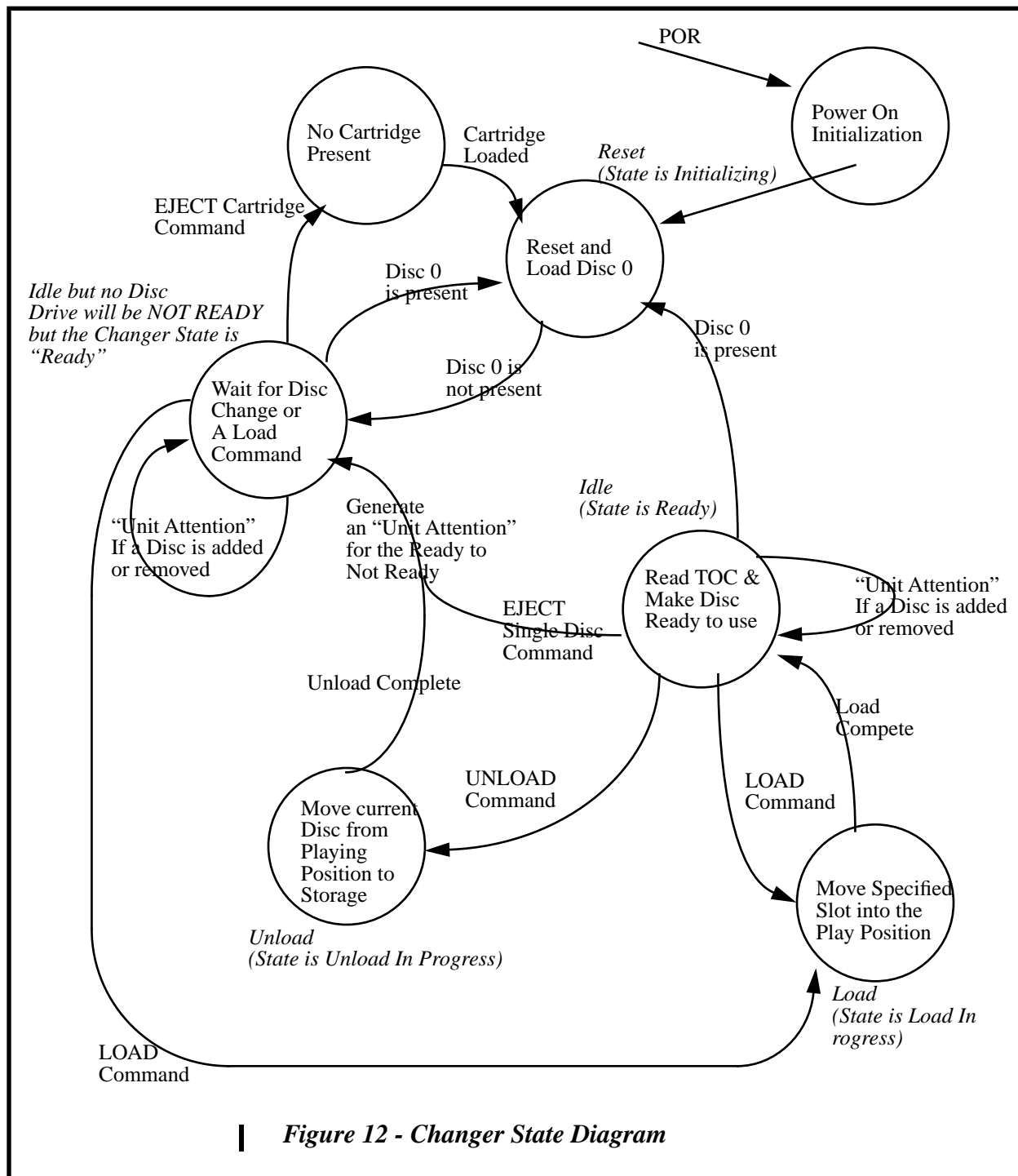

Figure 12 - Changer State Diagram

9.2 Changer Addressing

Several Changer specific commands use addresses called “Slots”.

If any commands related to Changer operations are implemented, then all the Changer commands *shall* be implemented. To determine if an ATAPI Drive is a changer type device, the Loading Mechanism Type field in the Capabilities page will contain one of the two changer type code (See "10.8.6.4 CD-ROM Capabilities and Mechanical Status Page" on page 118) for individual disc or cartridge implementations.

9.3 Automatic Load and Unload Operations

After initialization is complete the changer *shall* have Disc 0 loaded into the play position. This enables drivers which are not changer aware to work with a changer device as if it were a normal single Disc ATAPI CD-ROM device. This also insures compatibility with Bootable CD. In support of this goal the changer *shall* also load and unload (Eject) default Disc 0 if the changer supports loading and unloading (Ejecting) individual Discs unless otherwise commanded by the use of one of the changer specific Load/Unload command.

When a LOAD Command is received and a Disc is present in the Playing position, it *shall* be unloaded automatically before the specified Load operation is performed.

9.4 Delayed Disc load operation

CD Changer Devices may either move a disc into the playing position immediately upon receipt of a LOAD command, or delay the loading of the disc until a media access command is received. It is recommended that the device not load discs into the playing position until data from a disc that is not cached is requested from the host.

Note that Host Drivers should expect to encounter load mechanism delays on media accesses in addition to the spin up and seek delays normally introduced with these commands.

If the device supports delayed loading and the selected disc is not in the play position, then the following commands *shall* move the selected disc into the play position When data that has not been cached has been requested by the host:

Table 29 - Commands that may cause delayed loads to occur

Command
Play Audio (10)
Play Audio MSF
Play CD
Read (10)
Read (12)
Read CD
Read CD MSF
Read CD-ROM Capacity
Read Header
Read Sub-Channel
Read TOC
Scan

If the device supports delayed loading and the selected disc is not in the play position, then the following commands shall load the selected disc into the play position before execution of the command:

Table 30 - Commands that will cause delayed loads to occur

Command
Seek
Start/Stop Unit (LoEj=1)

If the device supports delayed loading and the selected disc is not in the play position, then the following commands shall not move the selected disc into the play position:

Table 31 - Commands that should not cause delayed loads to occur

Command
Stop Play / Scan
Start/Stop Unit (LoEj=0)
Test Unit Ready
Inquiry
Mechanism Status
Mode Select
Mode Sense
Prevent / Allow Medium Removal
Request Sense
Set CD Speed

9.5 Prevent / Allow processing

There are two techniques for Prevent / Allow, either all the discs shall be prevented from being ejected by the user or each disc individually shall be prevented. If the device reports support for Software Slot Selection, then each slot *shall* be individually controlled by the Prevent / Allow command. Note that changer devices that use a Cartridge and not individually controlled slots should not report the Software Slot Selection capability.

9.6 Error Reporting

If any of the following conditions occur during the execution of a command, the ATAPI Changer *shall* return CHECK CONDITION status. The appropriate sense key and additional sense code *shall* be set. The following list illustrates some error conditions and the applicable sense keys. The list does not provide an exhaustive enumeration of all conditions that may cause the CHECK CONDITION status.

Table 32 - Error Conditions and Sense Keys for Changer Mechanisms

Condition	Sense Key
Invalid Slot Number	ILLEGAL REQUEST
Unsupported option requested	ILLEGAL REQUEST
Load or Unload to invalid slot or no Disc in source location	ILLEGAL REQUEST
ATAPI CD-ROM Drive reset or medium change since last command	UNIT ATTENTION
Self diagnostic failed	HARDWARE ERROR

In the case of an invalid Slot number, the sense data information field *shall* be set to the Slot number of the first invalid address.

Attempts to eject a Disc if the changer type is cartridge and there is a Disc in the playing position *shall* be rejected with a Sense Key 05, (ILLEGAL REQUEST) Sense Code 01 (MECHANICAL POSITIONING OR CHANGER ERROR).

Intentionally Left Blank

10.0 CD-ROM Packet Commands

10.1 Packet Command Implementation Requirements

The first byte of all ATAPI CD-ROM Drive Command Packets *shall* contain an operation code as defined in this Specification. ATAPI CD-ROM Drives *shall* implement all commands with mandatory operation codes.

10.1.1 Reserved

Reserved bits, fields, bytes, and code values are set aside for future standardization. Their use and interpretation may be specified by future extensions to this or other standards. A reserved bit, field, or byte *shall* be set to zero, or in accordance with a future extension to this standard. The recipient *shall* not check reserved fields.

10.1.2 Operation Code Types

The operation code types are defined in Table 33 - below.

Table 33 - Operation Code Types

Operation Code Type	Description
M	Mandatory - Commands so designated <i>shall</i> be implemented in order to meet the minimum requirement of this Specification.
O	Optional - Commands so designated, if implemented, <i>shall</i> be implemented as defined in this Specification.
V	Vendor-specific - Operation codes so designated are available for vendor defined commands. See the vendor specifications where compatibility is desired.
R	Reserved - Operation codes so designated <i>shall not</i> be used. They are reserved for future extensions to this Specification.

10.2 ATAPI Command Packet Description

An ATAPI command is communicated by sending a Command Packet to the ATAPI CD-ROM Drive. For several commands, the Command Packet is accompanied by a list of parameters sent upon receiving an interrupt following the Command Packet being sent. See the specific commands for detailed information.

The Command Packet always has an operation code as its first byte.

For all commands, if there is an invalid parameter in the Command Packet, then the ATAPI Device *shall* abort the command without altering the medium.

Table 34 - Typical Command Packet for Most Commands

Byte	Bit	7	6	5	4	3	2	1	0
0		Operation Code							
1		Reserved			Reserved				
2	(MSB)	Logical Block Address (if required)							
3									
4									
5									
6		Reserved							
7 - 8	(MSB)	Transfer Length (if required) or Parameter List Length (if required) or Allocation Length (if required)(LSB)							
9		Reserved							
10		Reserved							
11		Reserved							

Table 35 - Typical Command Packet for Some Extended Commands

Byte	Bit	7	6	5	4	3	2	1	0
0		Operation Code							
1		Reserved			Reserved				
2	(MSB)	Logical Block Address (if required)							
3									
4									
5									
6	(MSB)	Transfer Length (if required) or Parameter List Length (if required) or Allocation Length (if required)							
7									
8									
9									
10		Reserved							
11		Reserved							

10.2.1 Operation Code

The operation code of the Command Packet has a group code field and a command code field. The three-bit group code field provides for eight groups of command codes. The five-bit command code field provides for thirty-two command codes in each group. Thus, a total of 256 possible operation codes exist. Operation codes are defined in the subsequent sections.

Table 36 - Operation Code

Bit	7	6	5	4	3	2	1	0
	Group Code			Command Code				

Note that the Group / Command code fields have been kept for backward compatibility and are not used by ATAPI.

10.2.2 Logical Block Address

The logical block address *shall* begin with block zero and be contiguous up to the last logical block.

10.2.3 Transfer Length

The Transfer Length Field specifies the amount of data to be transferred, usually the number of blocks. For several commands the transfer length indicates the requested number of bytes to be sent as defined in the command description. For these commands the Transfer Length Field may be identified by a different name. See the following descriptions and the individual command descriptions for further information.

In commands that use multiple bytes for the transfer length, a transfer length of zero indicates that no data transfer *shall* take place. A value of one or greater indicates the number of blocks that *shall* be transferred.

10.2.4 Parameter List Length

The Parameter List Length is used to specify the number of bytes to be sent to the Drive. This field is typically used in Command Packets for parameters that are sent to a Drive (e.g. mode parameters, diagnostic parameters, etc.). A parameter length of zero indicates that no data *shall* be transferred.

10.2.5 Allocation Length

The Allocation Length Field specifies the maximum number of bytes that a Host Computer has allocated for returned data. An allocation length of zero indicates that no data *shall* be transferred. The Drive *shall* terminate the data transfer when allocation length bytes have been transferred or when all available data have been transferred to the Host Computer, whichever is less. The allocation length is used to limit the maximum amount of data (e.g. sense data, mode data, etc.) returned to a Host Computer. When data is truncated, no error is generated, except for the Mechanism Status Command that *shall* generate a Parameter List Length Error.

10.3 Status

A Status byte *shall* be sent from the Drive to the Host Computer at the completion of each command unless the command is terminated by one of the following events:

1. A hard reset condition.
2. An unexpected event.

Status is normally presented at the end of a command, but in some cases may occur prior to transferring the Command Packet.

For a description of the Status Byte see "*Table 11 - ATAPI Status Register (ATA Status Register)*" on page 55.

10.4 Immediate Command Processing Considerations

Immediate commands are a class of commands which return completion status to the host system before they are finished executing the command. The purpose of immediate commands is to allow the host to execute more than one command at a time on the same IDE cable. An example of a typical overlapped cd-rom command execution would be to Play audio while accessing data from a disk drive on the same cable. In this example the host system would issue a Play Audio command. The ATAPI CD-Rom device would accept the command, and interrupt the host to return status. The host system is now free to issue additional commands to any other device at the same IDE port address including the ATAPI device executing the immediate command.

ATAPI devices use the DSC bit to indicate the completion status of the seek operation of immediate commands. No INTRQ is issued by these device when the DSC bit is set, so it the responsibility of the ATAPI driver to poll this bit to determine the completion status of the immediate command. See also "*5.6 Immediate Command Operation*" on page 23.

10.5 Command Processing Considerations and Exception Conditions

The following sections describe some exception conditions and errors associated with command processing and the sequencing of commands.

10.5.1 Parameter Rounding

Certain parameters sent to an ATAPI CD-ROM Drive with various commands contain a range of values. ATAPI CD-ROM Drives may choose to implement only selected values from this range. When the ATAPI CD-ROM Drive receives a value that it does not support, it either rejects the command (CHECK CONDITION status with ILLEGAL REQUEST sense key) or it rounds the value received to a supported value. The ATAPI CD-ROM Drive *shall* reject unsupported values unless rounding is permitted in the description of the parameter.

Rounding of parameter values, when permitted¹, *shall* be performed as follows - An ATAPI CD-ROM Drive that receives a parameter value that is not an exact supported value *shall* adjust the value to one that it supports and *shall* return CHECK CONDITION status with a sense key of RECOVERED ERROR. The additional sense code *shall* be set to ROUNDED PARAMETER. The Host Computer is responsible for issuing an appropriate command to learn what value the ATAPI CD-ROM Drive has selected.

10.6 Unit Attention Condition

The ATAPI CD-ROM Drive *shall* generate a unit attention whenever the ATAPI CD-ROM Drive has been reset by a hard reset condition, or by a power-on reset. The ATAPI CD-ROM Drive *shall* also generate a unit attention condition whenever one of the following events occurs:

1. A removable Disc or Cartridge may have been changed.
2. The version or level of microcode has been changed.

1. Generally, the ATAPI CD-ROM Drive should adjust maximum-value fields down to the next lower supported value than the one specified by the Host Computer. Minimum-value fields should be rounded up to the next higher supported value than the one specified by the Host Computer. In some cases, the type of rounding (up or down) is explicitly specified in the description of the parameter.

3. INQUIRY or Packet Identify Drive Data has been changed.
4. The mode parameters in effect for the Host Computer have been restored from non-volatile memory.
5. Any other event occurs that requires the attention of the Host Computer.
6. Any Disc or Cartridge has been manually moved within a Changer.

The ATAPI CD-ROM Drive may queue unit attention conditions. After the first unit attention condition is cleared, another unit attention condition may exist (e.g. a power on condition followed by a microcode change condition).

The unit attention condition *shall* persist, until the Host Computer clears the condition as described in the following paragraphs.

If an INQUIRY command is received from an Host Computer with a pending unit attention condition, the ATAPI CD-ROM Drive *shall* perform the INQUIRY command and *shall not* clear the unit attention condition.

If a REQUEST SENSE command is received from a Host Computer with a pending unit attention condition, then the ATAPI CD-ROM Drive *shall* either:

1. report any pending sense data and preserve the unit attention condition, or,
2. report the unit attention condition, may discard any pending sense data, and clear the unit attention condition.

If an Host Computer issues a command other than INQUIRY or REQUEST SENSE while a unit attention condition exists for that Host, the ATAPI CD-ROM Drive *shall not* perform the command and *shall* report CHECK CONDITION status unless a higher priority status as defined by the ATAPI CD-ROM Drive is also pending (e.g. BUSY).

10.7 Commands and Parameters

The ATAPI CD-ROM commands are derived from the SCSI CD-ROM command set.

With the exception of the CD-ROM MSF addressing technique, the interface uses logical rather than physical addressing for all data blocks. Each Device may be interrogated to determine how many blocks it contains.

Commands are classified as mandatory, optional, or vendor-specific. ATAPI CD-ROM drives are required to implement all mandatory commands and may implement other commands as well. ATAPI CD-ROM Drives contain commands that facilitate the writing of self-configuring software drivers that can discover all necessary attributes without prior knowledge of specific peripheral characteristics (such as storage capacity).

10.8 ATAPI Packet Commands for CD-ROM Devices

Table 37 - Packet Commands Supported by CD-ROM Drives

Command Description	Opcode	Type	Reference
INQUIRY	12h	M	section 10.8.1 on page 93
LOAD/UNLOAD CD	A6h	O**	section 10.8.2 on page 97
MECHANISM STATUS	BDh	M	section 10.8.3 on page 99
MODE SELECT (10)	55h	M	section 10.8.4 on page 103
MODE SENSE (10)	5Ah	M	section 10.8.5 on page 105
PAUSE/RESUME	4Bh	O*	section 10.8.7 on page 123
PLAY AUDIO (10)	45h	O*	section 10.8.8 on page 125
PLAY AUDIO MSF	47h	O*	section 10.8.9 on page 128
PLAY CD	BCh	O	section 10.8.10 on page 131
PREVENT/ALLOW MEDIUM REMOVAL	1Eh	M	section 10.8.11 on page 135
READ (10)	28h	M	section 10.8.12 on page 137
READ (12)	A8h	M	section 10.8.13 on page 139
READ CD-ROM CAPACITY	25h	M	section 10.8.14 on page 141
READ CD	BEh	M	section 10.8.15 on page 143
READ CD MSF	B9h	M	section 10.8.16 on page 155
READ HEADER	44h	M	section 10.8.17 on page 157
READ SUB-CHANNEL	42h	M	section 10.8.18 on page 161
READ TOC	43h	M	section 10.8.19 on page 169
REQUEST SENSE	03h	M	section 10.8.20 on page 179
SCAN	BAh	O	section 10.8.21 on page 187
SEEK	2Bh	M	section 10.8.22 on page 191
SET CD SPEED	BBh	O	section 10.8.23 on page 193
STOP PLAY / SCAN	4Eh	M	section 10.8.24 on page 195
START STOP UNIT	1Bh	M	section 10.8.25 on page 197
TEST UNIT READY	00h	M	section 10.8.26 on page 199
Reserved for future use	BFh		

Key: M = command implementation is mandatory.
O = command implementation is optional.
* = indicates a PLAY command. If any of the PLAY commands (indicated by an * in the type column) are implemented, all the PLAY commands *shall* be implemented by the ATAPI CD-ROM Drive.
** = indicates a Changer command. If any of the Changer commands (indicated by an ** in the type column) are implemented, all the Changer commands *shall* be implemented by the ATAPI CD-ROM Drive. Note that currently only the Load/Unload command has been defined.

10.8.1 INQUIRY Command

The INQUIRY command requests that information regarding parameters of the ATAPI CD-ROM Drive be sent to the Host Computer. An option allows the Host Computer to request additional information about the ATAPI CD-ROM Drive.

Table 38 - INQUIRY Command

Bit Byte	7	6	5	4	3	2	1	0
0	Operation code (12h)							
1	Reserved							Reserved
2	Reserved							
3	Reserved							
4	Allocation Length							
5	Reserved							
6	Reserved							
7	Reserved							
8	Reserved							
9	Reserved							
10	Reserved							
11	Reserved							

The INQUIRY command *shall* return CHECK CONDITION status only when the ATAPI CD-ROM Drive cannot return the requested INQUIRY data. The INQUIRY data should be returned even though the peripheral device may not be ready for other commands.

If an INQUIRY command is received with a pending unit attention condition (i.e. before the ATAPI CD-ROM Drive reports CHECK CONDITION status), the ATAPI CD-ROM Drive *shall* perform the INQUIRY command and *shall not* clear the unit attention condition.

10.8.1.1 Standard INQUIRY Data

The standard INQUIRY data contains 36 required bytes, followed by a variable number of vendor-specific parameters. Bytes 56 through 95, if returned, are reserved for future standardization.

Table 39 - INQUIRY Data Format

Bit Byte	7	6	5	4	3	2	1	0
0	Reserved			Peripheral Device Type				
1	RMB	Reserved						
2	ISO Version		ECMA Version			ANSI Version (00)		
3	ATAPI Version				Response Data Format			
4	Additional Length (Number of bytes following this one)							
5	Reserved							
6	Reserved							
7	Reserved							
8	Vendor Identification							
15								
16	Product Identification							
31								
32	Product Revision Level							
35								
36	Vendor-specific							
55								
56	Reserved							
95								
Vendor Specific Parameters								
96								
n								

The device-type fields identifies the device. It is defined in "Table 40 - Peripheral Device Types" on page 94.

10.8.1.2 Using the INQUIRY Command

The INQUIRY command may be used by a Host Computer to determine the configuration of the ATAPI CD-ROM Drive. ATAPI CD-ROM Drives respond with information that includes their type and Specification level and may include the vendor's identification, model number and other useful information.

Table 40 - Peripheral Device Types

Code	Description
00h	Direct-access device (e.g. magnetic disk)
01h - 04h	Reserved
05h	CD-ROM device
06h	Reserved
07h	Optical memory device (e.g. some optical disks)
08h - 1Eh	Reserved
1Fh	Unknown or no device type

The Peripheral Device Type *shall* be set to 05h to indicate a CD-ROM Device.

A Removable Medium Bit (RMB) of zero indicates that the medium is not removable. A RMB bit of one indicates that the medium is removable. CD-ROM Devices should always report "Removable".

The usage of non-zero code values in the ISO version and ECMA version fields are defined by the International Organization for Standardization and the European Computer Manufacturers Association, respectively.

The ANSI-approved version field must contain a zero to comply with this version of the Specification.

The ATAPI Version field must contain 02h to comply with this version of the Specification.

A response data format value of 01h indicates that the data *shall* be in the format specified in this Specification. Response data format values greater than one are reserved.

The Additional Length field *shall* specify the length in bytes of the parameters. If the allocation length of the Command Packet is too small to transfer all of the parameters, the additional length *shall* not be adjusted to reflect the truncation.

ASCII data fields *shall* contain only graphic codes (i.e. code values 20h through 7Eh). Left-aligned fields *shall* place any unused bytes at the end of the field (highest offset) and the unused bytes *shall* be filled with space characters (20h). Right-aligned fields *shall* place any unused bytes at the start of the field (lowest offset) and the unused bytes *shall* be filled with space characters (20h).

The Vendor Identification field contains 8 bytes of ASCII data identifying the vendor of the product¹. The data *shall* be left aligned within this field.

The Product Identification field contains 16 bytes of ASCII data as defined by the vendor. The data *shall* be left-aligned within this field.

The Product Revision Level field contains 4 bytes of ASCII data as defined by the vendor. The data *shall* be left-aligned within this field.

Table 41 - Recommended Sense Key, ASC and ASCQ for Inquiry Command Errors

Sense Key	ASC	ASCQ	Description of Error
05	20		INVALID COMMAND OPERATION CODE
05	24		INVALID FIELD IN COMMAND PACKET

1. It is intended that this field provide a unique vendor identification of the manufacturer of the ATAPI CD-ROM Drive. In the absence of a formal registration procedure, X3T9.2 maintains a list of vendor identification codes in use. Vendors are requested to voluntarily submit their identification codes to X3T9.2 to prevent duplication of codes.

Intentionally Left Blank

10.8.2 LOAD/UNLOAD CD Command

The LOAD / UNLOAD command requests that the ATAPI CD-ROM Drive changer load or unload a Disc. New Load / Unload Commands issued before the changer posts STATE= (00) READY, will cause the changer to abort the Load / Unload command in progress and begin processing the new Load / Unload CD command.

Table 42 - Load / Unload Command

Bit Byte	7	6	5	4	3	2	1	0
0	Operation code (A6h)							
1	Reserved			Reserved				Immed
2	Reserved							
3	Reserved							
4	Reserved						LoUnlo	Start
5	Reserved							
6	Reserved							
7	Reserved							
8	SLOT							
9	Reserved							
10	Reserved							
11	Reserved							

An immediate (Immed) bit of one indicates that the target shall return status as soon as the command descriptor block has been validated. An Immed bit of zero indicates that the status shall not be returned until the operation has been completed.

A Start bit of one requests the Device be made ready for use. A Start bit of zero requests that the Device be stopped (media cannot be accessed by the Host Computer).

Table 43 - Load/Unload or Optional Selection Operations

LoUnlo	Start	Operation to be Performed
0	0	Abort any Prior Changer Command (Stop)
0	1	Reserved
1	0	Unload Media. The SLOT Parameter is ignored for this operation.
1	1	Either Move the Disc in the selected SLOT to the play position or select the SLOT specified for use with future Media Access Commands

The SLOT field indicates the Slot to be loaded. Changers compatible with the Bootable CD-ROM specification should always initialize (Load) Slot 0 on Power On or Bus Device Reset.

Any attempt to Load or Unload a Disc when the Drive does not support that capability *shall* result in an error condition being reported to the Host (Sense key 05 ILLEGAL REQUEST, Sense Code 24 INVALID FIELD IN COMMAND PACKET.)

Loading when the slot does not contain a Disc will be rejected with a Sense Key 02 (NOT READY) and Sense Code 3A (MEDIUM NOT PRESENT). When this error is returned there are two possible actions by the CD Changer Device. If the device reports Software Slot Selection (SSS) = 1, then the slot specified shall be selected for use. If the device reports

SSS = 0 then the previously used slot shall continue to selected for use.

If the drive is capable of caching data then a delayed load of a disc into the playing position can be supported.

If delayed loading of a disc into the playing position is supported, the device SHALL have previously cached the TOC data from that disc. If the device has not read the TOC for a disc that is being loaded into the playing position, then delayed loading SHALL not be performed and the disc SHALL be loaded into the playing position immediately. If Caching of TOC data has been performed and the loading of the Disc into the playing position is delayed, then the drive SHALL report that the Disc is ready, even though the Disc is not spinning and installed in the playing position. In all cases the behavior seen by the host (other than a longer subsequent media access latency) shall not be different between delayed and immediate loading of a disc.

Note that an UNIT ATTENTION Condition *shall* not be generated when discs are loaded or unloaded from the playing position.

Unloading when the Play Position does not contain a Disc will be rejected with a Sense Key 05 (ILLEGAL REQUEST) and Sense Code 24 (INVALID FIELD IN COMMAND) for the Slot Byte.

Table 44 - recommended Sense Key, ASC and ASCQ for Load / Unload CD

Sense Key	ASC	ASCQ	Description of Error
02	05		MEDIA LOAD OR EJECT FAILED
05	20		INVALID COMMAND OPERATION CODE
05	24		INVALID FIELD IN COMMAND PACKET
05	01		MECHANICAL POSITIONING OR CHANGER ERROR
06	28		NOT READY TO READY TRANSITION
06	29		POWER ON, RESET OR BUS DEVICE RESET OCCURRED

10.8.3 MECHANISM STATUS Command

The MECHANISM STATUS command requests that the ATAPI CD-ROM Drive respond with the current status of the CD Device, including any Changer Mechanism that adheres to this specification. This command is intended to provide information to the Host about the current operational state of the Device. The CD Devices take operational direction from both the Host and the user (Person). Movement of media in/out of the device as well as Play type operations are at the whim of the user. This command has been provided to allow the Host to know what as transpired at the user level.

Table 45 - MECHANISM STATUS Command

Bit Byte	7	6	5	4	3	2	1	0
0	Operation code (BDh)							
1	Reserved							
2	Reserved							
3	Reserved							
4	Reserved							
5	Reserved							
6	Reserved							
7	Reserved							
8	MSB		Allocation Length				LSB	
9								
10	Reserved							
11	Reserved							

The Allocation Length field specifies the maximum length in bytes of the Slot Table Data that *shall* be transferred from the ATAPI CD-ROM Drive to the Host Computer. A parameter list length of zero indicates that no data *shall* be transferred. This condition *shall not* be considered as an error.

The ATAPI CD-ROM Drive *shall* terminate the command with CHECK CONDITION status if the parameter list length results in the truncation of any Mechanism Status header, or Slot Table page. The sense key *shall* be set to ILLEGAL REQUEST, and the additional sense code *shall* be set to PARAMETER LIST LENGTH ERROR. *Note: In the future, this error may be removed.*

The Mechanism Status List contains a header, followed by zero or more fixed-length Slot Tables. If the device does not support the changer commands, then the number of slot tables returned to the host *shall* be zero.

Table 46 - Mechanism Status Parameter List

Bit Byte	7	6	5	4	3	2	1	0
0 - 7	Mechanism Status Header							
8 - n	Slot Table(s)							

Each Slot Table contains the a slot number and status information.

Table 47 - Mechanism Status Header

Bit Byte	7	6	5	4	3	2	1	0
0	Fault	Changer State		Current Slot				
1	CD Mechanism State			Reserved				
2	MSB Current LBA LSB							
3								
4								
5								
6	MSB Length of Slot Table(s) LSB							
7								
8 - n								

- Bit 0-4 Current Slot

This field indicates the current Changer Slot selected. Changers compatible with a Bootable CD-ROM specification/standard, should always initialize (Load) Slot 0 on Power On or Bus Device Reset. This value *shall* only be changed when a Load Command is processed. Operations initiated by a user *shall* not cause this value to change. If the device is not a changer, then this field is reserved.
- Bit 5-6 Changer State

This field indicates the current state of the changer. If the device is not a changer, then this field is reserved.

 - 0h = Ready
 - 1h = Load in Progress
 - 2h = Unload in Progress
 - 3h = Initializing
- Bit 7 Fault

This bit indicates that the changer failed to complete the operation reported in the Changer State field. If the device is not a changer, then this bit is reserved.

Bit 7-5 CD Mechanism State This field encodes the current operation of CD Mechanism. If the device is not a changer, then this field is reserved.

0h Idle
1h Active with Audio Port in use (i.e. Playing Audio, Paused)
2h Audio Scan in progress
3h Active with Host, Composite or Other Ports in use (i.e. READ, PLAY CD, SCAN during a PLAY CD)
4-6h Reserved
7h No State Information Available

The Current LBA value returns the location that was last used while reading or playing. Once a Read or Play operation has been completed the value of this field may be undefined. While a Read or Play is in progress this field will contain the LBA of the current block being processed.

The Number of Slots Available field *shall* return the number of physical Slots that the device supports.

The Length of Slot Tables field specifies the length in bytes of the all the slot information that follows (e.g. for a 2 slot device this value would be 8).

Table 48 - Slot Table Response format

Bit Byte	7	6	5	4	3	2	1	0
0	Disc Present (Optional)							Change (Mandatory)
1	Reserved							
2	Reserved							
3	Reserved							

Bit 0 Change Change indicates that the Disc in that slot has been changed since the last time the Disc was loaded.

Bit 7 Disc Present This bit reports the presence of a Disc in a Slot, or if the Disc for a given Slot is in the Playing Position. A value of 1 indicates the Disc is present, and 0 indicates that it is not.

SDP=0 Changer devices may not support the capability of reporting the presence of a Disc in each of the slots after reset or a cartridge change. In this case the Device must report this in the capabilities mode page (See "10.8.6.4 CD-ROM Capabilities and Mechanical Status Page" on page 118 "Supports Disc Present Reporting bit (SDP)"). In this case the device *shall* report that ALL Discs are present, until the device can determine that there is no Disc present (i.e. when a Load Command is processed for an empty slot).

SDP=1 If the Changer device does support the reporting of the Disc Present then this bit shall be valid for all slots. It is not acceptable for the device to actually load and unload each slot to compute this information.

Table 49 - Recommended Sense Key, ASC and ASCQ for Mechanism Status

Sense Key	ASC	ASCQ	Description of Error
05	01		MECHANICAL POSITIONING OR CHANGER ERROR
05	1A		PARAMETER LIST LENGTH ERROR
05	20		INVALID COMMAND OPERATION CODE
05	26		INVALID FIELD IN PARAMETER LIST
06	28		NOT READY TO READY TRANSITION
06	29		POWER ON, RESET OR BUS DEVICE RESET OCCURRED

10.8.4 MODE SELECT Command

The MODE SELECT command provides a means for the Host Computer to specify medium, or peripheral device parameters to the ATAPI CD-ROM Drive. Host Computers *shall* issue MODE SENSE prior to each MODE SELECT to determine supported pages, page lengths, and other parameters.

Table 50 - Mode Select Command

Bit Byte	7	6	5	4	3	2	1	0
0	Operation code (55h)							
1	Reserved			1	Reserved			SP
2	Reserved							
3	Reserved							
4	Reserved							
5	Reserved							
6	Reserved							
7	Parameter List Length (MSB)							
8	Parameter List Length (LSB)							
9	Reserved							
10	Reserved							
11	Reserved							

A Save Pages (SP) bit of zero indicates the ATAPI CD-ROM Drive *shall* perform the specified MODE SELECT operation, and *shall not* save any pages. An SP bit of one indicates that the ATAPI CD-ROM Drive *shall* perform the specified MODE SELECT operation, and *shall* save to a non-volatile vendor-specific location all the savable pages. If an ATAPI CD-ROM Drive supports saved pages, it *shall* save only one copy of the page. The SP bit is optional, even when mode pages are supported by the ATAPI CD-ROM Drive. Pages that are saved are identified by the parameter savable bit that is returned in the page header by the MODE SENSE command. If the PS bit is set in the MODE SENSE data then the page *shall* be savable by issuing a MODE SELECT command with the SP bit set. If the ATAPI CD-ROM Drive does not implement saved pages and the SP bit is set to one, the command *shall* be terminated with CHECK CONDITION status. The sense key *shall* be set to ILLEGAL REQUEST, and the additional sense code set to INVALID FIELD IN COMMAND PACKET.

The Parameter List Length field specifies the length in bytes of the mode parameter list that *shall* be transferred from the Host Computer to the ATAPI CD-ROM Drive after the Command Packet is transferred. A parameter list length of zero indicates that no data *shall* be transferred. This condition *shall not* be considered as an error.

The ATAPI CD-ROM Drive *shall* terminate the command with CHECK CONDITION status if the parameter list length results in the truncation of any mode parameter header, or mode page. The sense key *shall* be set to ILLEGAL REQUEST, and the additional sense code *shall* be set to PARAMETER LIST LENGTH ERROR.

The mode parameter list for the MODE SELECT and MODE SENSE commands is defined in "10.8.6 Mode Select/Sense Parameters" on page 108.

The ATAPI CD-ROM Drive *shall* terminate the MODE SELECT command with CHECK CONDITION status, set the sense key to ILLEGAL REQUEST, set the additional sense code to INVALID FIELD IN PARAMETER LIST, and *shall not* change any mode parameters for the following conditions:

1. If the Host Computer sets any field (except for reserved fields) that is reported as not changeable by the ATAPI CD-ROM Drive to a value other than its current value.

2. If the Host Computer sets any unreserved field in the mode parameter header to an unsupported value.
3. If an Host Computer sends a mode page with a page length not equal to the page length returned by the MODE SENSE command for that page.
4. If the Host Computer sends an unsupported value for a mode parameter and rounding is not implemented for that mode parameter.

If the Host Computer sends a value for a mode parameter that is outside the range supported by the ATAPI CD-ROM Drive and rounding is implemented for that mode parameter, the ATAPI CD-ROM Drive may either:

1. round the parameter to an acceptable value and terminate the command;
2. terminate the command with CHECK CONDITION status, the sense key set to ILLEGAL REQUEST, and set the additional sense code to INVALID FIELD IN PARAMETER LIST.

An ATAPI CD-ROM Drive may alter any mode parameter in any mode page (even those reported as non-changeable) as a result of changes to other mode parameters¹.

The ATAPI CD-ROM Drive validates the non-changeable mode parameters against the current values that existed for those mode parameters prior to the MODE SELECT command.

Table 51 - Recommended Sense Key, ASC and ASCQ for Mode Select Command Errors

Sense Key	ASC	ASCQ	Description of Error
05	20		INVALID COMMAND OPERATION CODE
05	24		INVALID FIELD IN COMMAND PACKET
06	28		NOT READY TO READY TRANSITION
06	29		POWER ON, RESET OR BUS DEVICE RESET OCCURRED
06	2A	01	MODE PARAMETER CHANGED
05	26		INVALID FIELD IN PARAMETER LIST
05	00	11	PLAY OPERATION IN PROCESS

1. If the current values calculated by the ATAPI CD-ROM Drive affect the Host Computer's operation, the Host Computer *shall* issue a MODE SENSE command after each MODE SELECT command.

10.8.5 MODE SENSE Command

The MODE SENSE command provides a means for an ATAPI CD-ROM Drive to report parameters to the Host Computer. It is a complementary command to the MODE SELECT command.

Table 52 - Mode Sense command

Bit Byte	7	6	5	4	3	2	1	0
0	Operation code (5Ah)							
1	Reserved			Reserved	Reserved	Reserved		
2	PC			Page Code				
3	Reserved							
4	Reserved							
5	Reserved							
6	Reserved							
7	Allocation Length (MSB)							
8	Allocation Length (LSB)							
9	Reserved							
10	Reserved							
11	Reserved							

The Page Control (PC) field defines the type of mode parameter values to be returned in the mode pages. See sections "10.8.5.1 Current Values" - "10.8.5.4 Saved Values" below.

Table 53 - Page Control Field

Code	Type of Parameter	Section
00b	Current values	10.8.5.1 on page 106
01b	Changeable values	10.8.5.2 on page 106
10b	Default values	10.8.5.3 on page 106
11b	Saved values	10.8.5.4 on page 106

NOTE The Page Control field only affects the mode parameters within the mode pages, however the PS bit, Page Code and Page Length fields **shall** return current values since they have no meaning when used with other types. The mode parameter header **shall** return current values. (see also "10.8.6 Mode Select/Sense Parameters" on page 108)

The Page Code specifies which mode page(s) to return¹. See "Table 56 - Mode Page Codes for CD-ROM" on page 108 for a description of the Mode pages.

A Host Computer may request any one or all of the supported mode pages from an ATAPI CD-ROM Drive. If a Host Computer issues a MODE SENSE command with a page code value not implemented by the ATAPI CD-ROM Drive, the ATAPI CD-ROM Drive **shall** return CHECK CONDITION status and **shall** set the sense key to ILLEGAL REQUEST and the additional sense code to INVALID FIELD IN COMMAND PACKET.

A Page Code of 3Fh indicates that all mode pages implemented by the ATAPI CD-ROM Drive **shall** be returned to the Host Computer. If the mode parameter list exceeds 65536 bytes for a MODE SENSE command, the ATAPI CD-ROM Drive **shall** return CHECK CONDITION status and the sense key **shall** be set to ILLEGAL REQUEST and the addition-

1. Mode pages **shall** be returned in ascending page code order except for mode page 00h.

al sense code set to INVALID FIELD IN COMMAND PACKET.

Mode page 00h, if implemented, *shall* be returned after all other mode pages.

10.8.5.1 Current Values

A PC field value of 0h requests that the ATAPI CD-ROM Drive return the current values of the mode parameters. The current values returned are:

1. the current values of the mode parameters established by last successful MODE SELECT command.
2. the saved values of the mode parameters if a MODE SELECT command has not successfully completed since the last power-on, hard RESET condition.
3. the default values of the mode parameters, if saved values, are not available or not supported.

10.8.5.2 Changeable Values

A PC field value of 1h requests that the ATAPI CD-ROM Drive return a mask denoting those mode parameters that are changeable. In the mask, the fields of the mode parameters that are changeable shall be set to all one bits and the fields of the mode parameters that are non-changeable (i.e. defined by the ATAPI CD-ROM Drive) *shall* be set to all zero bits.

An attempt to change a non-changeable mode parameter (via MODE SELECT) results in an error condition.

The Host Computer *shall* issue a MODE SENSE command with the PC field set to 1h and the Page Code field set to 3Fh to determine which mode pages are supported, which mode parameters within the mode pages are changeable, and the supported length of each mode page prior to issuing any MODE SELECT commands.

10.8.5.3 Default Values

A PC field value of 2h requests that the ATAPI CD-ROM Drive return the default values of the mode parameters. Parameters not supported by the ATAPI CD-ROM Drive shall be set to zero. Default values are accessible even if the device is not ready.

10.8.5.4 Saved Values

A PC field value of 3h requests that the ATAPI CD-ROM Drive return the saved values of the mode parameters. Implementation of saved page parameters is optional. Mode parameters not supported by the ATAPI CD-ROM Drive *shall* be set to zero. If saved values are not implemented, the command *shall* be terminated with CHECK CONDITION status, the sense key set to ILLEGAL REQUEST and the additional sense code set to SAVING PARAMETERS NOT SUPPORTED.

The method of saving parameters is vendor-specific. The parameters are preserved in such a manner that they are retained when the ATAPI CD-ROM Drive is powered down. All savable pages can be considered saved when a MODE SELECT command issued with the SP bit set to one has returned a “good” status.

Note: As CD-ROM devices do not have writable media and the media is removable, most will not support Saved Values. It is recommended that the Host software not make use of saved pages.

10.8.5.5 Initial Responses

After a power-up condition or hard reset condition, the ATAPI CD-ROM Drive *shall* respond in the following manner:

1. If default values are requested, report the default values.

2. If saved values are requested, report valid restored mode parameters, or restore the mode parameters and report them. If the saved values of the mode parameters are not able to be accessed from the non-volatile, vendor-specific location, terminate the command with CHECK CONDITION status and set the sense key set to NOT READY. If saved parameters are not implemented, respond as defined in "10.8.5.4 Saved Values" on page 106.

If current values are requested and the current values of the mode parameters have not been sent by the Host Computer (via a MODE SELECT command), the ATAPI CD-ROM Drive may return either the default or saved values as defined above. If current values have been sent, the current values *shall* be reported.

Table 54 - Recommended Sense Key, ASC and ASCQ for Mode Sense Command Errors

Sense Key	ASC	ASCQ	Description of Error
05	20		INVALID COMMAND OPERATION CODE
05	24		INVALID FIELD IN COMMAND PACKET
06	28		NOT READY TO READY TRANSITION
06	29		POWER ON, RESET OR BUS DEVICE RESET OCCURRED
05	1A		PARAMETER LIST LENGTH ERROR
05	39		SAVING PARAMETERS NOT SUPPORTED

10.8.6 Mode Select/Sense Parameters

This section describes the pages used with MODE SELECT and MODE SENSE commands.

The Mode Parameter List contains a header, followed by zero or more variable-length pages.

Table 55 - Mode Parameter List

Bit Byte	7	6	5	4	3	2	1	0
0 - n	Mode Parameter Header							
0 - n	Page(s)							

Each mode page contains a page code, a page length, and a set of mode parameters.

Table 56 - Mode Page Codes for CD-ROM

Page code	Description	Section	Type
00h	Vendor-specific (does not require page format)		
01h	Read error recovery page	10.8.6.3 on page 114	M
02h - 0Ch	Reserved		
0Dh	CD-ROM page	10.8.6.2 on page 113	M
0Eh	CD-ROM audio control page	10.8.6.1 on page 111	M
2Ah	CD-ROM Capabilities & Mechanical Status Page	10.8.6.4 on page 118	M
0Fh - 1Fh	Reserved		
20h-29h, 2Bh-3Eh	Vendor-specific (page format required)		
3Fh	Return all pages (valid only for the MODE SENSE command)		

Table 57 - Mode Page Format

Bit Byte	7	6	5	4	3	2	1	0
0	PS/ Reserved	Reserved	Page Code					
1	Page Length (n-1)							
2	Mode Parameters							
n								

When using the MODE SENSE command, a Parameters Savable (PS) bit of one indicates that the mode page can be saved by the ATAPI CD-ROM Drive in a non-volatile, vendor-specific location. A PS bit of zero indicates that the supported parameters cannot be saved. When using the MODE SELECT command, the PS bit is reserved.

The Page Code field identifies the format and parameters defined for that mode page.

When using the MODE SENSE command, if Page Code 00h (vendor-specific page) is implemented, the ATAPI CD-ROM Drive *shall* return that page last in response to a request to return all pages (page code 3Fh). When using the

MODE SELECT command, this page *shall* be sent last.

The Page Length field specifies the length in bytes of the mode parameters that follow. If the Host Computer does not set this value to the value that is returned for the page by the MODE SENSE command, the ATAPI CD-ROM Drive *shall* terminate the command with CHECK CONDITION status. The sense key *shall* be set to ILLEGAL REQUEST with the additional sense code set to INVALID FIELD IN PARAMETER LIST. The ATAPI CD-ROM Drive is permitted to implement a mode page that is less than the full page length defined in this Specification, provided no field is truncated and the Page Length field correctly specifies the actual length implemented.

The mode parameters for each page are defined here. Mode parameters not implemented by the ATAPI CD-ROM Drive *shall* be set to zero.

Table 58 - Mode Parameter Header

Bit Byte	7	6	5	4	3	2	1	0	
0	MSB							Mode Data Length	
1								LSB	
2	Medium Type								
3	Reserved								
4	Reserved								
5	Reserved								
6	Reserved								
7									

When using the MODE SENSE command, the mode data length field specifies the length in bytes of the following data that is available to be transferred. The mode data length is the total byte count of all data following the mode data length field. When using the MODE SELECT command, this field is reserved.

Table 59 - CD-ROM Media Type Codes

Code	Medium Type Description
00h	Door closed / caddy inserted, medium type unknown
01h	120 mm CD-ROM data only, door closed or caddy inserted
02h	120 mm CD-DA audio only, door closed or caddy inserted
03h	120 mm CD-ROM data and audio combined, door closed or caddy inserted
04h	120 mm CD-ROM Hybrid disc (Photo CD), door closed or caddy inserted
05h	80 mm CD-ROM data only, door closed or caddy inserted
06h	80 mm CD-DA audio only, door closed or caddy inserted
07h	80 mm CD-ROM data and audio combined, door closed or caddy inserted
08h	80 mm CD-ROM Hybrid disc (Photo CD), door closed or caddy inserted
09h - 0Fh	Reserved
10h	Door closed / caddy inserted, medium type (CD-R) size unknown
11h	120 mm CD-ROM (CD-R) data only, door closed or caddy inserted
12h	120 mm CD-DA (CD-R) audio only, door closed or caddy inserted
13h	120 mm CD-ROM (CD-R) data and audio combined, door closed or caddy inserted
14h	120 mm CD-ROM (CD-R) Hybrid disc (Photo CD), door closed or caddy inserted
15h	80 mm CD-ROM (CD-R) data only, door closed or caddy inserted
16h	80 mm CD-DA (CD-R) audio only, door closed or caddy inserted
17h	80 mm CD-ROM (CD-R) data and audio combined, door closed or caddy inserted

Table 59 - CD-ROM Media Type Codes (Continued)

Code	Medium Type Description
18h	80 mm CD-ROM (CD-R) Hybrid disc (Photo CD), door closed or caddy inserted
19h - 1Fh	Reserved
20h	Door closed / caddy inserted, medium type (CD-E) size unknown
21h	120 mm CD-ROM (CD-E) data only, door closed or caddy inserted
22h	120 mm CD-DA (CD-E) audio only, door closed or caddy inserted
23h	120 mm CD-ROM (CD-E) data and audio combined, door closed or caddy inserted
24h	120 mm CD-ROM (CD-E Hybrid disc), door closed or caddy inserted
25h	80 mm CD-ROM (CD-E) data only, door closed or caddy inserted
26h	80 mm CD-DA (CD-E) audio only, door closed or caddy inserted
27h	80 mm CD-ROM (CD-E) data and audio combined, door closed or caddy inserted
28h	80 mm CD-ROM (CD-E) Hybrid disc, door closed or caddy inserted
29h - 2Fh	Reserved
30h	Door closed / caddy inserted, medium type unknown
31h	120 mm (HD) door closed or caddy inserted
32h - 34h	Reserved
35h	80 mm (HD) door closed or caddy inserted
36h - 6Fh	Reserved
70h	Door closed, no disc present
71h	Door open or no caddy inserted
72h	Door closed or caddy inserted, medium format error
73h - 7Fh	Reserved
80h - FFh	Vendor-specific

10.8.6.1 CD-ROM Audio Control Parameters Page

The CD-ROM Audio Control Parameters Page sets the playback modes and output controls for subsequent PLAY AUDIO commands and any current audio playback operation.

Table 60 - CD-ROM Audio Control Mode Page Format

Bit Byte	7	6	5	4	3	2	1	0
0	PS (Optional)	Reserved	Page Code (0Eh)					
1	Page Length (0Eh)							
2	Reserved					Immed (Mandatory) Always 1	SOTC (Mandatory) Default 0	Reserved
3	Reserved							
4	Reserved							
5	Reserved							
6	Logical Block Per Second of Audio Playback							
7	Default 75							
8	Reserved				CDDA Output Port 0 Channel Selection			
9	Output Port 0 Volume (Mandatory) Default FFh							
10	Reserved				CDDA Output Port 1 Channel Selection			
11	Output Port 1 Volume (Mandatory) Default FFh							
12	Reserved				CDDA Output Port 2 Channel Selection			
13	Output Port 2 Volume (Optional) Default 00h							
14	Reserved				CDDA Output Port 3 Channel Selection			
15	Output Port 3 Volume (Optional) Default 00h							

The Parameters Savable (PS) bit is only used with the MODE SENSE command. The PS bit is optional. This bit is reserved with the MODE SELECT command. A PS bit of one indicates that the ATAPI CD-ROM Drive is capable of saving the page in a non-volatile vendor-specific location.

The Immediate Bit (Immed) is used for information purposes only; the audio commands will always send completion status as soon as the playback operation has been started. This bit *shall* always be set to 1.

A Stop On Track Crossing (SOTC) bit of zero indicates the ATAPI CD-ROM Drive *shall* terminate the audio playback operation when the transfer length is satisfied. Multiple tracks *shall* be played as necessary. Periods of time encoded as audio pause/silence at the beginning of tracks, (index 0) *shall* also be played. A SOTC bit of one indicates the ATAPI CD-ROM Drive *shall* terminate the audio playback operation when the beginning of a following track is encountered. The SOTC bit is mandatory.

The CDDA Output Port Channel Selection field specifies the Red Book audio channels from the disc to which a specific output port *shall* be connected. More than one output port may be connected to an audio channel. More than one audio channel may be connected to an output port.

Table 61 - CDDA Output Port Channel Selection Codes

Code	Description
0000b	Output port muted
0001b	Connect audio channel 0 to this output port
0010b	Connect audio channel 1 to this output port
0011b	Connect audio channel 0 and audio channel 1 to this output port
0100b	Connect audio channel 2 to this output port
1000b	Connect audio channel 3 to this output port

The Output Port Volume Control indicates the relative volume level for this audio output port. The value used is specified as an attenuation of the normal volume level. A value of zero indicates the minimum volume level (Mute), and a value of FFh indicates maximum volume (No attenuation) level. It is recommended that the MUTE and volume functions should be supported on a per channel basis. The attenuation used *shall* be as specified in "Table 62 - Attenuation Levels for Audio". All values not shown in the table *shall* be valid, with the attenuation selected by interpolating using the known table values.

It is recommended that the Drive support at least 16 volume levels. The actual attenuation levels for any given Binary attenuation value *shall* be given by the following equation: $20 \text{ Log (Binary Level / 256)}$

Note: Audio channel volume control regarding channel selection of MUTE vs. Volume Level setting of 0. It is recommend that drives allow the setting of the Channel Selection fields to MUTE and also allow the setting of the Volume Level field to 0. It is up to the drive to determine how to shut off the volume, either via muting circuitry or via the volume control.

Table 62 - Attenuation Levels for Audio

Binary Level	Attenuation
FFh	0db (On)
F0h	-0.56
E0h	-1.16
C0h	-2.50
80h	-6.00
40h	-12.0
20h	-18.0
10h	-24.0
0Fh	-24.6
0Eh	-25.2
0Ch	-26.6
08h	-30.0
04h	-36.0
02h	-42.1
01h	-48.0
00h	Mute (Off)

10.8.6.2 CD-ROM Device Parameters Page

The CD-ROM Device parameters page specifies parameters that affect all CD-ROM data types.

Table 63 - CD-ROM Parameters Page Format

Bit Byte	7	6	5	4	3	2	1	0
0	PS (Optional) Default 0	Reserved	Page Code (0Dh)					
1	Page Length (06h)							
2	Reserved							
3	Reserved				Inactivity Time Multiplier			
4	MSB		Number of MSF - S Units per MSF - M Unit				LSB	
5	Default 60 (3Ch)							
6	MSB		Number of MSF - F Units per MSF - S Unit				LSB	
7	Default 75 (4Bh)							

The Parameters Savable (PS) bit is only used with the MODE SENSE command. This bit is reserved with the MODE SELECT command. A PS bit of one indicates that the ATAPI CD-ROM Drive is capable of saving the page in a non-volatile vendor-specific location. The PS bit is optional.

The Inactivity Timer Multiplier specifies the length of time that the drive *shall* remain in the hold track state after completion of a seek or read operation.

NOTE Higher values in this parameter may have an adverse effect on the drive MTBF, in some implementations.

Table 64 - Inactivity Time Multiplier Values

Inactivity Timer Multiplier	Minimum Time in Hold Track State	Inactivity Timer Multiplier	Minimum Time in Hold Track State
0h	Vendor-specific	8h	16s
1h	125 ms	9h	32s
2h	250 ms	Ah	1 min
3h	500 ms	Bh	2 min
4h	1 s	Ch	4 min
5h	2 s	Dh	8 min
6h	4 s	Eh	16 min
7h	8 s	Fh	32 min

The number of S units per M unit field gives the ratio of these MSF address values. For media conforming to the CD-ROM and CD-DA Specification, this value is 60.

The number of F units per S unit field gives the ratio of these MSF address values. For media conforming to the CD-ROM and CD-DA Specification, this value is 75.

10.8.6.3 Read Error Recovery Parameters Page

The Read Error Recovery Parameters Page specifies the error recovery parameters the ATAPI CD-ROM Drive *shall* use during any command that performs a data read operation from the media (e.g. READ, READ TOC, etc.).

Table 65 - Read Error Recovery Parameters Page Format

Bit Byte	7	6	5	4	3	2	1	0
0	PS (Optional) Default 0	Reserved	Page Code (01h)					
1	Page Length (06h)							
2	Error Recovery Parameter, Default 0							
	Reserved		TB	RC	Reserved	PER	DTE	DCR
3	Read Retry Count							
4	Reserved							
5	Reserved							
6	Reserved							
7	Reserved							

The Parameters Savable (PS) bit is only used with the MODE SENSE command. This bit is reserved with the MODE SELECT command. A PS bit of one indicates that the ATAPI CD-ROM Drive is capable of saving the page in a non-volatile vendor-specific location. The PS bit is optional.

NOTE The implementation of error recovery procedures for CD-ROM devices is markedly different from those used for magnetic medium disk drives. At least one level of error correction (i.e. CIRC) is required to transfer the data stream. Therefore, the performance of the drive may differ substantially from what would be expected by sending the same error recovery parameters to a magnetic medium device.

A Transfer Block (TB) bit of one indicates that a data block that is not recovered within the recovery limits specified, *shall* be transferred to the Host Computer before CHECK CONDITION status is returned. A TB bit of zero indicates that such a data block *shall not* be transferred to the Host Computer. The TB bit does not affect the action taken for recovered data.

A Read Continuous (RC) bit of one indicates that the CD-ROM drive *shall* transfer the entire requested length of data without adding delays to perform error recovery procedures. This implies that the CD-ROM drive may send data that is erroneous or fabricated in order to maintain a continuous flow of data. A RC bit of zero indicates that error recovery operations that cause delays are acceptable during the data transfer.

A Post Error (PER) bit of one indicates that the CD-ROM drive *shall* report recovered errors. A PER bit of zero indicates that the CD-ROM drive *shall not* report recovered errors. Error recovery procedures *shall* be performed within the limits established by the error recovery parameters.

A Disable Transfer on Error (DTE) bit of one indicates that the CD-ROM drive *shall* terminate the data transfer to the Host upon detection of a recovered error. A DTE bit of zero indicates that the CD-ROM drive *shall not* terminate the data transfer upon detection of a recovered error.

A Disable Correction (DCR) bit of one indicates that error correction codes *shall not* be used for data error recovery. A DCR bit of zero allows the use of error correction codes for data error recovery.

The correlation of the error recovery parameter and the bit settings defined for CD-ROM devices is given in "Table 66 - Error Recovery Bit Settings" on page 115. The interpretation of these bit settings for CD-ROM devices is given in "Table 67 - CD-ROM Error Recovery Descriptions" on page 115. If the error recovery parameter is set to any other value, the

command *shall* be terminated with CHECK CONDITION status. The sense key *shall* be set to ILLEGAL REQUEST and the additional sense code set to INVALID FIELD IN PARAMETER LIST.

Table 66 - Error Recovery Bit Settings

Error Recovery Parameter	Bit Settings 7 6 5 4 3 2 1 0	Error Recovery Parameter	Bit Settings 7 6 5 4 3 2 1 0
00h	R R 0 0 R 0 0 0	20h	R R 1 0 R 0 0 0
01h	R R 0 0 R 0 0 1	21h	R R 1 0 R 0 0 1
04h	R R 0 0 R 1 0 0	24h	R R 1 0 R 1 0 0
05h	R R 0 0 R 1 0 1	25h	R R 1 0 R 1 0 1
06h	R R 0 0 R 1 1 0	26h	R R 1 0 R 1 1 0
07h	R R 0 0 R 1 1 1	27h	R R 1 0 R 1 1 1
10h	R R 0 1 R 0 0 0	30h	R R 1 1 R 0 0 0
11h	R R 0 1 R 0 0 1	31h	R R 1 1 R 0 0 1
14h	R R 0 1 R 1 0 0	34h	R R 1 1 R 1 0 0
15h	R R 0 1 R 1 0 1	35h	R R 1 1 R 1 0 1

NOTE Reserved bits *shall* be set to zero.

Table 67 - CD-ROM Error Recovery Descriptions

Code	Error Recovery Description
00h	The maximum error recovery procedures available are used. If an error occurs which is uncorrectable with the error correction codes (ECC) on the media, data transfer is terminated with CHECK CONDITION status. The block with the error is not transferred. The sense key is set to MEDIUM ERROR. The information bytes give the address of the block where the unrecovered error was detected. Recovered errors are not reported.
01h	Only retries of the read operation and CIRC are used (layered error correction is not used). Only CIRC unrecovered data errors are reported. If a CIRC unrecovered data error occurs, data transfer is terminated with CHECK CONDITION status. The block with the error is not transferred. The sense key is set to MEDIUM ERROR. The information bytes give the address of the block where the unrecovered error was detected. Recovered errors are not reported.
04h	The maximum error recovery procedures available are used. Recovered data errors are reported. If a recovered data error occurs, data transfer is not terminated. However, when the data transfer has completed CHECK CONDITION status is reported. The sense key is set to RECOVERED ERROR. The information bytes give the address of the last block where a recovered data error was detected. If a data error occurs that is uncorrectable with the ECC information available on the media, data transfer is terminated and CHECK CONDITION status is reported. The block with the error is not transferred. The sense key is set to MEDIUM ERROR. The information bytes give the address of the block where the uncorrectable error was detected.
05h	Only retries of the read operation and CIRC are used (layered error correction is not used). Recovered data errors are reported. If a recovered data error occurs, data transfer is not terminated. However, when the data transfer has completed CHECK CONDITION status is reported. The sense key is set to RECOVERED ERROR. The information bytes give the address of the last block where a CIRC recovered data error was detected. If an unrecovered data error occurs, data transfer is terminated and CHECK CONDITION status is reported. The block with the error is not transferred. The sense key is set to MEDIUM ERROR. The information bytes give the address of the block where the unrecovered error was detected.

Table 67 - CD-ROM Error Recovery Descriptions

Code	Error Recovery Description
06h	The maximum error recovery procedures are used. Recovered data errors are reported. If a recovered data error occurs data transfer is terminated and CHECK CONDITION status is reported. The block with the recovered error is not transferred. The sense key is set to RECOVERED ERROR. The information bytes give the address of the block where the recovered data error was detected. If a data error occurs that is uncorrectable with the ECC information on the medium, data transfer is terminated with CHECK CONDITION status. The block with the error is not transferred. The sense key is set to MEDIUM ERROR. The information bytes give the address of the block where the uncorrectable error was detected.
07h	Only retries of the read operation are used (layered error correction is not used) and CIRC recovered data errors are reported. If a CIRC recovered data error occurs, data transfer is terminated with CHECK CONDITION status. The block with the recovered error is not transferred. The sense key is set to RECOVERED ERROR. The information bytes give the address of the block where the recovered data error was detected. If a CIRC unrecovered data error occurs, data transfer is terminated with CHECK CONDITION status. The block with the error is not transferred. The sense key is set to MEDIUM ERROR. The information bytes give the address of the block where the unrecovered error was detected.
10h	If data transfer can be maintained, the maximum error recovery procedures available are used. (RC = 1.) If an error occurs which is uncorrectable with the error correction codes (ECC) on the media, or is uncorrectable in time to maintain data transfer, the data transfer is not terminated. However, when the data transfer has completed, CHECK CONDITION status is reported. The sense key is set to MEDIUM ERROR. The information bytes give the address of the block where the first unrecovered error was detected. Recovered errors are not reported.
11h	If data transfer can be maintained, retries of the read operation and CIRC are used (layered error correction is not used). (RC = 1.) Only CIRC unrecovered data errors are reported. If a CIRC unrecovered data error occurs, data transfer is not terminated. However, when the data transfer has completed, CHECK CONDITION status is reported. The sense key is set to MEDIUM ERROR. The information bytes give the address of the block where the first unrecovered error was detected. Recovered errors are not reported.
14h	If data transfer can be maintained, the maximum error recovery procedures available are used. (RC = 1.) Recovered data errors are reported. If a recovered data error occurs, data transfer is not terminated. However, when the data transfer has completed, CHECK CONDITION status is reported. The sense key is set to RECOVERED ERROR. The information bytes give the address of the block where a recovered data error was detected. If an data error occurs that is uncorrectable with the ECC information available on the media, or is uncorrectable in time to maintain data transfer, the data transfer is not terminated. However, when the data transfer has completed CHECK CONDITION, status is reported. The sense key is set to MEDIUM ERROR. The information bytes give the address of the block where the first uncorrectable error was detected. Reporting unrecovered errors takes precedence over reporting recovered errors.
15h	If data transfer can be maintained, retries of the read operation and CIRC are used (layered error correction is not used). (RC = 1.) Recovered data errors are reported. If a recovered data error occurs, data transfer is not terminated. However, when the data transfer has completed CHECK CONDITION status is reported. The sense key is set to RECOVERED ERROR. The information bytes give the address of the block where a CIRC recovered data error was detected. If an unrecovered data error occurs, data transfer is not terminated. However, when the data transfer has completed CHECK CONDITION status is reported. The sense key is set to MEDIUM ERROR. The information bytes give the address of the block where the first unrecovered error was detected. Reporting unrecovered errors takes precedence over reporting recovered errors.
20h	The maximum error recovery procedures available are used. If an error occurs which is uncorrectable with the error correction codes (ECC) on the media, data transfer is terminated with CHECK CONDITION status. The block with the error is transferred. The sense key is set to MEDIUM ERROR. The information bytes give the address of the block where the unrecovered error was detected. Recovered errors are not reported.
21h	Only retries of the read operation and CIRC are used (layered error correction is not used). Only CIRC unrecovered data errors are reported. If a CIRC unrecovered data error occurs data transfer is terminated with CHECK CONDITION status. The block with the error is transferred. The sense key is set to MEDIUM ERROR. The information bytes give the address of the block where the unrecovered error was detected. Recovered errors are not reported.
24h	The maximum error recovery procedures available are used. Recovered data errors are reported. If a recovered data error occurs data transfer is not terminated. However, when the data transfer has completed, CHECK CONDITION status is reported. The sense key is set to RECOVERED ERROR. The information bytes give the address of the last block where a recovered data error was detected. If a data error occurs that is uncorrectable with the ECC information available on the media data transfer is terminated and CHECK CONDITION status is reported. The block with the error is transferred. The sense key is set to MEDIUM ERROR. The information bytes give the address of the block where the uncorrectable error was detected.

Table 67 - CD-ROM Error Recovery Descriptions

Code	Error Recovery Description
25h	Only retries of the read operation and CIRC are used (layered error correction is not used). Recovered data errors are reported. If a recovered data error occurs, data transfer is not terminated. However, when the data transfer has completed, CHECK CONDITION status is reported. The sense key is set to RECOVERED ERROR. The information bytes give the address of the last block where a CIRC recovered data error was detected. If an unrecovered data error occurs, data transfer is terminated and CHECK CONDITION status is reported. The block with the error is transferred. The sense key is set to MEDIUM ERROR. The information bytes give the address of the block where the unrecovered error was detected.
26h	The maximum error recovery procedures are used. Recovered data errors are reported. If a recovered data error occurs, data transfer is terminated and CHECK CONDITION status is reported. The block with the recovered error is transferred. The sense key is set to RECOVERED ERROR. The information bytes give the address of the block where the recovered data error was detected. If a data error occurs that is uncorrectable with the ECC information on the media, data transfer is terminated with CHECK CONDITION status. The block with the error is transferred. The sense key is set to MEDIUM ERROR. The information bytes give the address of the block where the uncorrectable error was detected.
27h	Only retries of the read operation are used (layered error correction is not used). CIRC recovered data errors are reported. If a CIRC recovered data error occurs, data transfer is terminated with CHECK CONDITION status. The block with the recovered error is transferred. The sense key is set to RECOVERED ERROR. The information bytes give the address of the block where the recovered data error was detected. If a CIRC unrecovered data error occurs, data transfer is terminated with CHECK CONDITION status. The block with the error is transferred. The sense key is set to MEDIUM ERROR. The information bytes give the address of the block where the unrecovered error was detected.
30h	Same as code 10H.
31h	Same as code 11H.
34h	Same as code 14H.
35h	Same as code 15H.

The Read Retry Count field specifies the number of times that the controller *shall* attempt its read recovery algorithm.

A CIRC Recovered Data Error is defined as a block for which the CIRC based error correction algorithm was unsuccessful for a read attempt, but on a subsequent read operation no error was reported. The number of subsequent read operations is limited to the read retry count. Layered error correction was not used.

A CIRC Unrecovered Data Error is defined as a block for which the CIRC based error correction algorithm was unsuccessful on all read attempts up to the read retry count. Layered error correction was not used.

An L-EC Recovered Data Error is defined as a block for which the CIRC based error correction algorithm was unsuccessful, but the layered error correction was able to correct the block within the read retry count.

An L-EC Uncorrectable Data Error is defined as a block which could not be corrected by layered error correction within the read retry count.

10.8.6.4 CD-ROM Capabilities and Mechanical Status Page

The Capabilities Page is read only and may not be set with Mode Select.

Table 68 - CD-ROM Capabilities and Mechanical Status Page Format

Bit Byte	7	6	5	4	3	2	1	0
0	PS	Reserved	Page Code (2Ah)					
1	Page Length (12h)							
2	Reserved					Method 2	CD-E Rd	CD-R Rd
3	Reserved						CD-E Wr	CD-R Wr
4	Reserved	Multi Session	Mode 2 Form 2	Mode 2 Form 1	Digital Port(2)	Digital Port(1)	Composite	AudioPlay
5	Reserved	UPC	ISRC	C2Pointers	R-W De-interleaved & corrected	R-W Supported	DAAccu	CD DA
6	Loading Mechanism Type			Reserved	Eject	Prevent Jumper	Lock State	Lock
7	Reserved				S/W Slot Selection (SSS)	Supports Disc Present (SDP)	Separate Channel Mute	Separate volume
8	(MSB)							
9	Maximum Speed Supported (in KBps)							(LSB)
10	(MSB)							
11	Number of Volume Levels Supported							(LSB)
12	(MSB)							
13	Buffer Size supported by Drive (in KBytes)							(LSB)
14	(MSB)							
15	Current Speed Selected (in KBps)							(LSB)
16	Reserved							
17	Reserved	Length			LSBF	RCK	BCK	Reserved
18	Reserved							
19	Reserved							

Media Function Capabilities:

If CD-R Read Field is set to one, the drive *shall* support the read function of CD-R disc (Orange Book Part II).

If CD-E Read Field is set to one, the drive *shall* support the read function of CD-E disc (Orange Book Part III).

If Method 2 is set to one, the drive *shall* support the read function of CD-R media written using fixed packet tracks using Addressing Method 2.

If CD-R Write Field is set to one, the drive *shall* support the write function of CD-R disc (Orange Book Part II).

If CD-E Write Field is set to one, the drive *shall* support the write function of CD-E disc (Orange Book Part III).

The individual capabilities of the drive are specified by bytes 4 through 7. Each of the bits indicate if that specific capability is supported. A value of zero indicates that the capability is NOT supported; a value of one indicates the capability IS supported.

Bit 0	Audio Play	The drive is capable of Audio Play operation. This also indicates that the drive is capable of overlapping Play and other commands such as reading of the Sub-channel information.
Bit 1	Composite	The drive is capable of delivering a composite Audio and Video data stream.
Bit 2	Digital Port(1)	The drive supports digital output (IEC958) on port 1
Bit 3	Digital Port(2)	The drive supports digital output(IEC958) on port 2
Bit 4	Mode 2 Form 1	The drive is capable of reading sectors in Mode 2 Form 1 (XA) format.
Bit 5	Mode 2 Form 2	The drive is capable of reading sectors in Mode 2 Form 2 format.
Bit 6	Multi Session	The drive is capable of reading multiple session or Photo-CD discs.
Bit 8	CD-DA Commands Supported	Red Book audio can be read using the READ-CD command.
Bit 9	CD-DA Stream is Accurate	<p>This bit indicates that the drive supports an advanced feature that allows it to return to an audio location without losing place to continue the READ CD-DA command.</p> <p>0 The drive is incapable of accurately restarting the CD-DA read operation, and a BUFFER OVERFLOW error <i>shall</i> be reported whenever a loss of streaming occurs. This error will be fatal and the command will have to be repeated from the beginning.</p> <p>1 The drive can continue from a loss of streaming condition and no error will be generated.</p>
Bit 10	R-W Supported	The commands that return Sub-channel data can return the combined R-W information.
Bit 11	R-W De-interleaved & Corrected	This indicates that the R-W sub-channel data will be returned de-interleaved and error corrected.
Bit 12	C2 Pointers are Supported	This indicates that the drive supports the C2 Error Pointers. This also indicates that the drive is capable of returning the C2 Error Pointers and C2 Block Error flags in the READ CD command.
Bit 13	ISRC	The drive can return the International Standard Recording Code Information.
Bit 14	UPC	The drive can return the Media Catalog Number (UPC)
Bit 16	Lock	The PREVENT/ALLOW command is capable of actually locking the media into the drive.
Bit 17	Lock State	<p>This indicates the current state of the drive.</p> <p>0 The drive is currently in the allow (Unlocked) state. Media may be inserted or ejected.</p> <p>1 The drive is currently in the prevent (Locked) state. Media loaded in the drive may not be removed via a soft or hard eject. If the drive is empty, media may not be inserted if the Prevent Jumper is not present. If the jumper is present, then media may be inserted.</p>

Bit 18	Prevent Jumper	This indicates the state of the (Optional) Prevent/Allow Jumper. 0 Jumper is present. Drive will power up to the allow state. Locking the drive with the Prevent/Allow Command <i>shall</i> NOT prevent the insertion of media. 1 Jumper is not present. Drive will power up to the Prevent State (Locked). The drive will not accept new media or allow the ejection of media already loaded until an allow command is issued.
Bit 19	Eject Command	The drive can eject the disc via the normal START/STOP command with the LoEj bit set. If the mechanism is a Changer that uses a Cartridge, then this bit indicates that the Cartridge can be ejected.
Bit 20	Reserved	Reserved
Bit 23-21	Loading Mechanism Type	This field specifies the type of disc loading the drive supports. 23 22 21 0 0 0 Caddy type loading mechanism 0 0 1 Tray type loading mechanism 0 1 0 Pop-up type loading mechanism 0 1 1 Reserved 1 0 0 Changer with individually changeable discs 1 0 1 Changer using a Cartridge Mechanism 1 1 0 Reserved 1 1 1 Reserved
Bit 24	Separate Volume Levels	The audio level for each channel can be controlled independently.
Bit 25	Separate Channel Mute	The mute capability for each channel can be controlled independently.
Bit 26	Supports Disc Present (SDP)	This bit indicates that the Device contains an embedded changer, and that after a reset condition or if a cartridge is changed, it can report the exact contents of the slots. The response to the MECHANISM STATUS command will contain valid Disc is Present status information for all slots.
Bit 27	Software Slot Selection (SSS)	This bit controls the behavior of the LOAD/UNLOAD command when trying to load a Slot with no Disc present (see "Table 43 - Load/Unload or Optional Selection Operations" on page 97).

The Maximum Speed Supported field indicates the actual maximum data rate that the drive supports. This value is re-

turned as the number of kilobytes per/second (Speed/1000) that the data is read from the drive.

Table 69 - Example Data Rates

Speed	Data Rate
X1	176 KBytes/second
X2	353 KBytes/second
X2.2	387 KBytes/second
X3	528 KBytes/second
X4	706 KBytes/second
X8	1.4 MBytes/second
X16	2.8 MBytes/second

Note that these are the raw data rates and do not reflect any overhead resulting from headers, error correction data, etc. It is also important to understand that the reported data rate is a theoretical maximum and the actual data rates to the host will be lower. The data rates are dynamic and will change as the drive changes its speed.

The Number of Volume Levels Supported field returns the number of discrete levels. If the drive only supports turning audio on and off, the Number of Volume Levels field *shall* be set to 2.

The Buffer Size Supported field returns the number of bytes of buffer dedicated to the data stream returned to the Host Computer. This value is returned in Kbytes (Size/1024). If the drive does not have a buffer cache, the value returned *shall* be zero.

The Current Speed Selected field indicates the actual data rate that the drive is currently using. This value is returned as the number of kilobytes per/second (Speed/1000) that the data is read from the drive.

Byte 17 is used to describe the format of the drives digital output.

Bit 1	BCKF	Set if data valid on the falling edge of the BCK signal. Clear if data valid on the rising edge of the BCK signal								
Bit 2	RCK	Set if HIGH on LRCK indicates left channel. Clear if HIGH on LRCK indicates right channel.								
Bit 3	LSBF	Set if LSB first. Clear if MSB first.								
Bit 4-5	Length	<table style="width: 100%; border-collapse: collapse;"> <tbody> <tr> <td style="width: 20%;">00</td> <td>32 BCKs</td> </tr> <tr> <td>01</td> <td>16 BCKs</td> </tr> <tr> <td>10</td> <td>24 BCKs</td> </tr> <tr> <td>11</td> <td>24 BCKs (I²S)</td> </tr> </tbody> </table>	00	32 BCKs	01	16 BCKs	10	24 BCKs	11	24 BCKs (I ² S)
00	32 BCKs									
01	16 BCKs									
10	24 BCKs									
11	24 BCKs (I ² S)									

Intentionally Left Blank

10.8.7 PAUSE/RESUME Command

The PAUSE/RESUME command requests that the device stop or start an audio play operation. This command is used with PLAY AUDIO commands that are currently executing.

Table 70 - PAUSE/RESUME Command

Bit Byte	7	6	5	4	3	2	1	0
0	Operation Code (4Bh)							
1	Reserved							
2	Reserved							
3	Reserved							
4	Reserved							
5	Reserved							
6	Reserved							
7	Reserved							
8	Reserved							Resume
9	Reserved							
10	Reserved							
11	Reserved							

A Resume bit of zero causes the drive to enter the hold track state with the audio output muted after the current block is played. A Resume bit of one causes the drive to release the pause/scan and begin play at the block following the last block played/scanned.

If an audio play operation cannot be resumed and the resume bit is one, the command is terminated with CHECK CONDITION status. If the resume bit is zero and an audio play operation cannot be paused, (no audio play operation has been requested, or the requested audio play operation has been completed), the command is terminated with CHECK CONDITION status. See "Figure 15 - Stop Play/Play Audio/Audio Scan/Pause/Resume Sequencing" on page 196 for additional information.

It **shall not** be considered an error to request a PAUSE when a pause is already in effect or to request a RESUME when a play operation is in progress.

Table 71 - Recommended Sense Key, ASC and ASCQ for Pause/Resume Command Errors

Sense Key	ASC	ASCQ	Description of Error
05	20		INVALID COMMAND OPERATION CODE
05	24		INVALID FIELD IN COMMAND PACKET
06	28		NOT READY TO READY TRANSITION
06	29		POWER ON, RESET OR BUS DEVICE RESET OCCURRED
02	04	00	LOGICAL DRIVE NOT READY - CAUSE NOT REPORTABLE
02	04	01	LOGICAL DRIVE NOT READY - IN PROGRESS OF BECOMING READY
02	04	02	LOGICAL DRIVE NOT READY - INITIALIZING COMMAND REQUIRED
02	04	03	LOGICAL DRIVE NOT READY - MANUAL INTERVENTION REQUIRED
02	3A		MEDIUM NOT PRESENT
0B	B9		PLAY OPERATION ABORTED

Intentionally Left Blank

10.8.8 PLAY AUDIO Command

The PLAY AUDIO command requests that the ATAPI CD-ROM Drive begin an audio playback operation. The command function and the output of audio signals *shall* be as specified by the settings of the mode parameters, including the SOTC bit.

Table 72 - PLAY AUDIO Command

Bit Byte	7	6	5	4	3	2	1	0
0	Operation Code (45h)							
1	Reserved							
2	Starting Logical Block Address							
3								
4								
5								
6	Reserved							
7	Transfer Length							
8								
9	Reserved							
10	Reserved							
11	Reserved							

This command responds with immediate status, allowing overlapped commands. This command *shall* set the DSC bit upon command completion. See also "10.4 Immediate Command Processing Considerations" on page 90.

If any commands related to audio operations are implemented then the PLAY AUDIO (10) command *shall* be implemented to allow a method for the Host Computer to determine if audio operations are supported. An ATAPI CD-ROM Drive responding to a PLAY AUDIO (10) command that has a transfer length of zero with CHECK CONDITION status and setting the sense key to ILLEGAL REQUEST does not support audio play operations.

The Starting Logical Block Address field specifies the logical block at which the audio playback operation *shall* begin. PLAY AUDIO commands with a starting logical block address of FFFF FFFFh *shall* implement audio play from the current location of the optics. PLAY AUDIO commands with a starting LBA address of 0000 0000h shall begin the audio play operation at 00m 02s 00f.

The Transfer Length Field specifies the number of contiguous logical blocks that *shall* be played. A Transfer Length Field of zero indicates that no audio operation *shall* occur. This condition *shall not* be considered an error.

If the starting address is not found, if the address is not within an audio track, or if a not ready condition exists, the command *shall* be terminated with CHECK CONDITION status.

If the CD-ROM information type (data vs. audio) changes within the transfer length, the command *shall* be terminated with a CHECK CONDITION and the sense key *shall* be set to ILLEGAL REQUEST and the additional sense code set to END OF USER AREA ENCOUNTERED ON THIS TRACK.

If the logical block address requested is not within an audio track, the command *shall* be terminated with CHECK CONDITION status. The sense key *shall* be set to ILLEGAL REQUEST and the additional sense code set to ILLEGAL MODE FOR THIS TRACK.

Table 73 - Recommended Sense Key, ASC and ASCQ for Play Audio Command Errors

Sense Key	ASC	ASCQ	Description of Error
05	20		INVALID COMMAND OPERATION CODE
05	24		INVALID FIELD IN COMMAND PACKET
06	28		NOT READY TO READY TRANSITION
06	29		POWER ON, RESET OR BUS DEVICE RESET OCCURRED
02	04	00	LOGICAL DRIVE NOT READY - CAUSE NOT REPORTABLE
02	04	01	LOGICAL DRIVE NOT READY - IN PROGRESS OF BECOMING READY
02	04	02	LOGICAL DRIVE NOT READY - INITIALIZING COMMAND REQUIRED
02	04	03	LOGICAL DRIVE NOT READY - MANUAL INTERVENTION REQUIRED
02	3A		MEDIUM NOT PRESENT
02	06	00	NO REFERENCE POSITION FOUND (media may be upside down)
03	02		NO SEEK COMPLETE
05	21		LOGICAL BLOCK ADDRESS OUT OF RANGE
05	63		END OF USER AREA ENCOUNTERED ON THIS TRACK
05	64		ILLEGAL MODE FOR THIS TRACK OR INCOMPATIBLE MEDIUM

10.8.8.1 Play Audio with Immediate Packet Commands

The PLAY AUDIO and AUDIO SCAN commands will continue to play while other commands are processed by the drive. Some commands can be accepted without disrupting the audio operations, while others will cause the Play operation to stop. The following section describes the operation of other commands while playing audio.

A PLAY AUDIO and AUDIO SCAN command will be terminated when any of the commands in "Table 74 - Commands That Will Stop a Play or Scan Operation" are received.

Table 74 - Commands That Will Stop a Play or Scan Operation

Opcode(s)	Command Description
A6h	LOAD / UNLOAD CD
4Bh	PAUSE/RESUME
45h	PLAY AUDIO (10)
47h	PLAY AUDIO MSF
B4h	PLAY CD
28h	READ (10)
A8h	READ (12)
BCh	READ CD
44h	READ HEADER
D5h	READ CD MSF
2Bh	SEEK
DAh	SET CD-ROM SPEED
1Bh	START/STOP UNIT

ATA commands other than A2, A0 will stop play or scan.

The CD-ROM drive should accept and perform the commands specified in "Table 74 - Commands That Will Stop a Play or Scan Operation" without terminating an AUDIO PLAY command already in progress. See "Figure 15 - Stop Play/Play Audio/Audio Scan/Pause/Resume Sequencing" on page 196 for additional information.

Table 75 - Commands That Will Not Stop a Play or Scan Operation

Opcode	Command Description	Action Taken
ANY	When it generates an Illegal Field in Command Packet CHECK CONDITION.	Will terminate normally
12h	INQUIRY	The Inquiry data will be returned
BDh	MECHANISM STATUS	Will execute normally
55h	MODE SELECT	The Mode Select will be accepted and executed as long as no Media or Mode information is changed. If parameters that affect the play are changed, the Mode Select will terminate with a CHECK CONDITION without being executed.
5Ah	MODE SENSE	Will execute normally
1Eh	PREVENT/ALLOW MEDIA REMOVAL	Will execute normally
25h	READ CD-ROM CAPACITY	Will execute normally
42h	READ SUB-CHANNEL	Only the current position information (Format Code 01h) will be supported while the play is in progress. If any other type of information is requested the READ SUB-CHANNEL will not be executed and a CHECK CONDITION will be generated.
43h	READ TOC	Only drives that cache the TOC will be able to respond to this command while the play is in progress. If the drive does not support caching the TOC, the command will not be executed and a CHECK CONDITION will be generated.
03h	REQUEST SENSE	Will execute normally
D8h	SCAN	SCAN command will be executed and the PLAY command will resume at completion of the scan
00h	TEST UNIT READY	Will execute normally

10.8.9 PLAY AUDIO MSF Command

The PLAY AUDIO MSF command requests that the ATAPI CD-ROM Drive begin an audio playback operation. The command function and the output of audio signals *shall* be as specified by the settings of the mode parameters including the SOTC bit described on page 111.

Table 76 - PLAY AUDIO MSF Command

Bit Byte	7	6	5	4	3	2	1	0
0	Operation Code (47h)							
1	Reserved							
2	Reserved							
3	Starting M Field							
4	Starting S Field							
5	Starting F Field							
6	Ending M Field							
7	Ending S Field							
8	Ending F Field							
9	Reserved							
10	Reserved							
11	Reserved							

This command responds with immediate status, allowing overlapped commands. This command *shall* set the DSC bit upon command completion. See also "10.4 Immediate Command Processing Considerations" on page 90.

The Starting M field, the Starting S field, and the Starting F field specify the absolute MSF address at which the audio play operation *shall* begin. The Ending M field, the Ending S field, and the Ending F field specify the absolute MSF address where the audio play operation *shall* end. All contiguous audio sectors between the starting and the ending MSF address *shall* be played.

If the Starting Minutes, Seconds and Frame Fields are set to FFh, the Starting address is taken from the Current Optical Head location. This allows the Audio Ending address to be changed without interrupting the current playback operation.

A Starting MSF address equal to an ending MSF address causes no audio play operation to occur. This *shall not* be considered an error. If the Starting MSF address is greater than the Ending MSF address, the command *shall* be terminated with CHECK CONDITION status. The sense key *shall* be set to ILLEGAL REQUEST.

If the starting address is not found, if the address is not within an audio track, or if a not ready condition exists, the command *shall* be terminated with CHECK CONDITION status.

See "10.8.8.1 Play Audio with Immediate Packet Commands" on page 126 for information on overlapped commands during an Audio Playback.

Table 77 - Recommended Sense Key, ASC and ASCQ for Play Audio MSF Command Errors

Sense Key	ASC	ASCQ	Description of Error
05	20		INVALID COMMAND OPERATION CODE
05	24		INVALID FIELD IN COMMAND PACKET
06	28		NOT READY TO READY TRANSITION
06	29		POWER ON, RESET OR BUS DEVICE RESET OCCURRED
02	04	00	LOGICAL DRIVE NOT READY - CAUSE NOT REPORTABLE
02	04	01	LOGICAL DRIVE NOT READY - IN PROGRESS OF BECOMING READY
02	04	02	LOGICAL DRIVE NOT READY - INITIALIZING COMMAND REQUIRED
02	04	03	LOGICAL DRIVE NOT READY - MANUAL INTERVENTION REQUIRED
02	3A		MEDIUM NOT PRESENT
02	06	00	NO REFERENCE POSITION FOUND (media may be upside down)
03	02		NO SEEK COMPLETE
05	21		LOGICAL BLOCK ADDRESS OUT OF RANGE
05	63		END OF USER AREA ENCOUNTERED ON THIS TRACK
05	64		ILLEGAL MODE FOR THIS TRACK OR INCOMPATIBLE MEDIUM

Intentionally Left Blank

10.8.10 PLAY CD Command

The PLAY CD command provides one standard, universal way of sending digital CD data to an external device (e.g. an IEC958 or EBU port).

Table 78 - PLAY CD Command (LBA Form)

Bit Byte	7	6	5	4	3	2	1	0								
0	Operation Code (BCh)															
1	Reserved			Expected Sector Type			MSF (0)	Reserved								
2	Starting Logical Block Address															
3																
4																
5									LSB							
6									Transfer Length in Blocks							
7																
8																
9	LSB															
10	SPEED	Reserved			Port 2	Port 1	Composite	Audio								
11	Reserved															

Table 79 - PLAY CD Command (MSF Form)

Bit Byte	7	6	5	4	3	2	1	0
0	Operation code (B4h)							
1	Reserved			Expected Sector Type			MSF (1)	Reserved
2	Reserved							
3	Starting M Field							
4	Starting S Field							
5	Starting F Field							
6	Ending M Field							
7	Ending S Field							
8	Ending F Field							
9	Reserved							
10	SPEED	Reserved			Port 2	Port 1	Composite	Audio
11	Reserved							

The Expected Sector Type field is used to check the sector type only. If the Requested Sector(s) do not match the specified type, the command will be terminated with a CHECK CONDITION. The Sector that does not match will not be transferred to output port. The sense key *shall* be set to ILLEGAL MODE FOR THIS TRACK.

Implementer's Note: The Expected Sector Type is used to generate an error and terminate the transfer when the sectors found on the media, do not match the type desired. This field has NO control of the actual number of bytes transferred.

Table 80 - PLAY CD, Expected Sector Type Field Definition

Expected Sector Type	Definition	Description
000b	Any Type (Mandatory)	No checking of the Sector Type will be performed. The device <i>shall</i> always terminate a command, at the sector where a transition between CD-Rom and CD-DA occurs.
001b	CD DA (Mandatory)	Only Red Book (CD-DA) sectors <i>shall</i> be allowed. An attempt to read any other format <i>shall</i> result in the reporting of an error.
010b	Mode 1 (Mandatory)	Only Yellow Book sectors which have a "user" data field of 2048 bytes <i>shall</i> be allowed. An attempt to read any other format <i>shall</i> result in the reporting of an error.
011b	Mode 2 (Mandatory)	Only Yellow Book sectors which have a "user" data field of 2336 bytes <i>shall</i> be allowed. An attempt to read any other format <i>shall</i> result in the reporting of an error.
100b	Mode 2 Form 1 (Mandatory)	Only Green Book sectors which have a "user" data field of 2048 <i>shall</i> be allowed. An attempt to read any other format <i>shall</i> result in the reporting of an error.
101b	Mode 2 Form 2 (Mandatory)	Only Green Book sectors which have a "user" data field of 2324 <i>shall</i> be allowed. An attempt to read any other format <i>shall</i> result in the reporting of an error. Note that the spare data is included in the user data making the size 2324+4= 2328.
110b - 111b		Reserved

See also, CD-ROM Sector Formats on page 73.

Table 81 - PLAY CD, Field Definition

Flag	Value	Description
Audio	0	Analog Audio Channel is Disabled
	1	Analog Audio Channel is Enabled
Composite	0	Composite Video port is Disabled
	1	Composite Video port is Enabled
Port 1	0	Digital Port 1 is Disabled
	1	Digital Port 1 is Enabled
Port 2	0	Digital Port 2 is Disabled
	1	Digital Port 2 is Enabled
SPEED	0	Speed will be set to x1 for the operation
	1	The Speed used will be the best possible

Table 82 - Recommended Sense Key, ASC and ASCQ for PLAY CD Command Errors

Sense Key	ASC	ASCQ	Description of Error
05	20		INVALID COMMAND OPERATION CODE
05	24		INVALID FIELD IN COMMAND PACKET
06	28		NOT READY TO READY TRANSITION
06	29		POWER ON, RESET OR BUS DEVICE RESET OCCURRED
02	04	00	LOGICAL DRIVE NOT READY - CAUSE NOT REPORTABLE
02	04	01	LOGICAL DRIVE NOT READY - IN PROGRESS OF BECOMING READY
02	04	02	LOGICAL DRIVE NOT READY - INITIALIZING COMMAND REQUIRED
02	04	03	LOGICAL DRIVE NOT READY - MANUAL INTERVENTION REQUIRED
02	06	00	NO REFERENCE POSITION FOUND (media may be upside down)
02	3A		MEDIUM NOT PRESENT
03	02		NO SEEK COMPLETE
05	21		LOGICAL BLOCK ADDRESS OUT OF RANGE
05	64		ILLEGAL MODE FOR THIS TRACK OR INCOMPATIBLE MEDIUM
05	00	11	PLAY OPERATION IN PROGRESS
0B	BF		LOSS OF STREAMING

Intentionally Left Blank

10.8.11 PREVENT/ALLOW MEDIUM REMOVAL Command

The PREVENT/ALLOW MEDIUM REMOVAL command requests that the ATAPI CD-ROM Drive enable or disable the removal of the medium. The prevention of media removal (when implemented) *shall* be accomplished through the use of a Locking Mechanism. The locking mechanism is optional and an error *shall* be returned if a command to prevent medium removal is issued (Sense key 05 ILLEGAL REQUEST, Sense Code 24 INVALID FIELD IN COMMAND PACKET).

Table 83 - PREVENT ALLOW MEDIUM REMOVAL Command

Bit Byte	7	6	5	4	3	2	1	0
0	Operation Code (1Eh)							
1	Reserved							
2	Reserved							
3	Reserved							
4	Reserved							Prevent
5	Reserved							
6	Reserved							
7	Reserved							
8	Reserved							
9	Reserved							
10	Reserved							
11	Reserved							

The prevention of medium removal *shall* begin when the Host Computer issues a PREVENT/ALLOW MEDIUM REMOVAL command with a prevent bit of one (medium removal prevented). The prevention of medium removal *shall* terminate:

1. after the Host Computer has issued a PREVENT ALLOW MEDIUM REMOVAL command with a prevent bit of zero (Unlock), and the ATAPI CD-ROM Drive has successfully performed a synchronize cache operation; or
2. upon a hard RESET condition; or
3. if the drive does not support a locking mechanism.

While a prevention of medium removal condition is in effect (Locked) the ATAPI CD-ROM Drive *shall* inhibit mechanisms that normally allow removal of the medium by an operator. This is also the case for changers.

The default state of the drive at power on is unlocked, unless the drive supports a prevent/allow jumper and the jumper is in the prevent state (See "10.8.6.4 CD-ROM Capabilities and Mechanical Status Page" on page 118.)

This command will affect the actions of the START/STOP UNIT command (See "10.8.25 START/STOP UNIT Command" on page 197) and other mechanisms external to this specification (manual ejection / media removal systems.)

Table 84 - Actions for Lock / Unlock / Eject

Operation	Locked / Unlocked	If Drive Not Ready (No Media)	If Drive Ready (Media Present)
Unlock (Prevent = 0)	Unlocked	No Error	No Error
	Locked	No Error, Now media may be inserted	No Error, Now media may be removed
Lock (Prevent = 1)	Unlocked	No Error, Drive door locked and will not allow media to be inserted	No Error, Drive door locked and will not allow media to be removed
	Locked	No Error	No Error
Lock when the drive does not support a Locking Mechanism	Would always be Unlocked	Error: 05 ILLEGAL REQUEST, 24 INVALID FIELD IN COMMAND PACKET	Error: 05 ILLEGAL REQUEST, 24 INVALID FIELD IN COMMAND PACKET
Eject (START/STOP UNIT command with LoEj set)	Unlocked	No Error and Tray is opened	No Error: Media Ejects
	Locked	Error: 02 Not ready, 53 Media Removal Prevented	Error: 02 Not ready, 53 Media Removal Prevented
Manual Eject	Unlocked	Tray opens (If tray exists)	Media is Ejected
	Locked	No operation occurs	No operation, Media stays locked in drive

Table 85 - Recommended Sense Key, ASC and ASCQ for Prevent/Allow Command Errors

Sense Key	ASC	ASCQ	Description of Error
05	20		INVALID COMMAND OPERATION CODE
05	24		INVALID FIELD IN COMMAND PACKET
06	28		NOT READY TO READY TRANSITION
06	29		POWER ON, RESET OR BUS DEVICE RESET OCCURRED
02	04	00	LOGICAL DRIVE NOT READY - CAUSE NOT REPORTABLE
02	04	01	LOGICAL DRIVE NOT READY - IN PROGRESS OF BECOMING READY
02	04	02	LOGICAL DRIVE NOT READY - INITIALIZING COMMAND REQUIRED
02	04	03	LOGICAL DRIVE NOT READY - MANUAL INTERVENTION REQUIRED
02	3A		MEDIUM NOT PRESENT
02	53	02	MEDIA REMOVAL PREVENTED

10.8.12 READ (10) Command

The READ (10) command requests that the ATAPI CD-ROM Drive transfer data to the Host Computer. The most recent data value written in the addressed logical block *shall* be returned.

Table 86 - READ (10) Command

Bit Byte	7	6	5	4	3	2	1	0
0	Operation Code (28h)							
1	Reserved							
2	Logical Block Address							
3								
4								
5								
6	Reserved							
7	Transfer Length							
8								
9	Reserved							
10	Reserved							
11	Reserved							

The Transfer Length field specifies the number of contiguous logical blocks of data that *shall* be transferred. A transfer length of zero indicates that no logical blocks *shall* be transferred. This condition *shall not* be considered an error. Any other value indicates the number of logical blocks that *shall* be transferred.

Although the CD-ROM is capable of returning a variety of data, this command *shall* only return the “User Data” portion of the sector. This field is **always** 2048 bytes in length for Mode 1 and Mode 2 Form 1 sectors, which are the only sector types allowed. For all other sector types, the device *shall* set the ILI bit in the Request Sense Standard Data and return a “ILLEGAL MODE FOR THIS TRACK” error if any read to them using this command is attempted.

Table 87 - Recommended Sense Key, ASC and ASCQ for READ (10) Command Errors

Sense Key	ASC	ASCQ	Description of Error
05	20		INVALID COMMAND OPERATION CODE
05	24		INVALID FIELD IN COMMAND PACKET
06	28		NOT READY TO READY TRANSITION
06	29		POWER ON, RESET OR BUS DEVICE RESET OCCURRED
02	04	00	LOGICAL DRIVE NOT READY - CAUSE NOT REPORTABLE
02	04	01	LOGICAL DRIVE NOT READY - IN PROGRESS OF BECOMING READY
02	04	02	LOGICAL DRIVE NOT READY - INITIALIZING COMMAND REQUIRED
02	04	03	LOGICAL DRIVE NOT READY - MANUAL INTERVENTION REQUIRED
02	06	00	NO REFERENCE POSITION FOUND (media may be upside down)
02	3A		MEDIUM NOT PRESENT
03	02		NO SEEK COMPLETE
05	21		LOGICAL BLOCK ADDRESS OUT OF RANGE
05	64		ILLEGAL MODE FOR THIS TRACK OR INCOMPATIBLE MEDIUM
03	11	05	L-EC UNCORRECTABLE ERROR
03	11	06	CIRC UNRECOVERED ERROR
01	17	01	RECOVERED DATA WITH RETRIES
01	18	01	RECOVERED DATA WITH ERROR CORRECTION & RETRIES APPLIED
01	18	04	RECOVERED DATA WITH L-EC

10.8.13 READ (12) Command

The READ (12) command requests that the ATAPI CD-ROM Drive transfer data to the Host Computer. The most recent data value written in the addressed logical block *shall* be returned.

Table 88 - READ (12) Command

Bit Byte	7	6	5	4	3	2	1	0
0	Operation Code (A8h)							
1	Reserved							
2	Logical Block Address							
3								
4								
5								
6	Transfer Length							
7								
8								
9								
10	Reserved							
11	Reserved							

The Transfer Length field specifies the number of contiguous logical blocks of data that *shall* be transferred. A transfer length of zero indicates that no logical blocks *shall* be transferred. This condition *shall not* be considered an error. Any other value indicates the number of logical blocks that *shall* be transferred.

Although the CD-ROM is capable of returning a variety of data, this command *shall* only return the “User Data” portion of the sector. This field is **always** 2048 bytes in length for Mode 1 and Mode 2 Form 1 sectors, which are the only sector types allowed. For all other sector types, the device *shall* set the ILI bit in the Request Sense Standard Data and return a “ILLEGAL MODE FOR THIS TRACK” error if any read to them using this command is attempted.

Table 89 - Recommended Sense Key, ASC and ASCQ for READ (10) Command Errors

Sense Key	ASC	ASCQ	Description of Error
05	20		INVALID COMMAND OPERATION CODE
05	24		INVALID FIELD IN COMMAND PACKET
06	28		NOT READY TO READY TRANSITION
06	29		POWER ON, RESET OR BUS DEVICE RESET OCCURRED
02	04	00	LOGICAL DRIVE NOT READY - CAUSE NOT REPORTABLE
02	04	01	LOGICAL DRIVE NOT READY - IN PROGRESS OF BECOMING READY
02	04	02	LOGICAL DRIVE NOT READY - INITIALIZING COMMAND REQUIRED
02	04	03	LOGICAL DRIVE NOT READY - MANUAL INTERVENTION REQUIRED
02	06	00	NO REFERENCE POSITION FOUND (media may be upside down)
02	3A		MEDIUM NOT PRESENT
03	02		NO SEEK COMPLETE
05	21		LOGICAL BLOCK ADDRESS OUT OF RANGE
05	64		ILLEGAL MODE FOR THIS TRACK OR INCOMPATIBLE MEDIUM
03	11	05	L-EC UNCORRECTABLE ERROR
03	11	06	CIRC UNRECOVERED ERROR
01	17	01	RECOVERED DATA WITH RETRIES
01	18	01	RECOVERED DATA WITH ERROR CORRECTION & RETRIES APPLIED
01	18	04	RECOVERED DATA WITH L-EC

10.8.14 READ CD-ROM CAPACITY Command

The READ CD-ROM CAPACITY command provides a means for the Host Computer to request information regarding the capacity of the Device. The general function of the CD-ROM version of READ CAPACITY is the same but the exact definition of the returned logical block address is modified to allow returning a possibly inexact value (but one with a known error boundary) based on CD-ROM table of contents data. This error boundary occurs when the last track is an audio track, and could cause the last block to be +/- 75 sectors from the actual end of the track. This error is a tolerance in the addressing of Audio data built into the Media specifications for CD-ROM. For many CD-ROM devices, this implementation allows a quicker response.

Table 90 - READ CD-ROM CAPACITY Command

Bit Byte	7	6	5	4	3	2	1	0
0	Operation code (25h)							
1	Reserved							
2	Reserved							
3	Reserved							
4	Reserved							
5	Reserved							
6	Reserved							
7	Reserved							
8	Reserved							
9	Reserved							
10	Reserved							
11	Reserved							

Eight bytes of READ CD-ROM CAPACITY data *shall* be returned to the Host Computer.

Table 91 - READ CAPACITY DATA

Bit Byte	7	6	5	4	3	2	1	0
0	MSB Logical Block Address							
1								
2								
3	LSB							
4	MSB Block Length in Bytes (Length reported <i>shall</i> be 2048d)							
5								
6								
7								

Table 92 - Recommended Sense Key, ASC and ASCQ for Read Capacity Command Errors

Sense Key	ASC	ASCQ	Description of Error
05	20		INVALID COMMAND OPERATION CODE
05	24		INVALID FIELD IN COMMAND PACKET
06	28		NOT READY TO READY TRANSITION
06	29		POWER ON, RESET OR BUS DEVICE RESET OCCURRED
02	04	00	LOGICAL DRIVE NOT READY - CAUSE NOT REPORTABLE
02	04	01	LOGICAL DRIVE NOT READY - IN PROGRESS OF BECOMING READY
02	04	02	LOGICAL DRIVE NOT READY - INITIALIZING COMMAND REQUIRED
02	04	03	LOGICAL DRIVE NOT READY - MANUAL INTERVENTION REQUIRED
02	06	00	NO REFERENCE POSITION FOUND (media may be upside down)
02	3A		MEDIUM NOT PRESENT

10.8.15 READ CD Command

The READ CD command (Family) provides one standard, universal way of accessing CD data. Rather than breaking the types of data into several related commands, this command is generic to all CD data types.

This command returns any of the CD data streams, including the headers, EDC and ECC, ROM data and CD-DA data. Each type of data is enabled via the use of flags. These flags indicate which information from the CD is to be returned in the data stream. If a flag is cleared, then that particular information will not be returned. If all the flags are cleared, no data will be returned to the host and this condition is not treated as an error.

Table 93 - READ CD Command

Bit Byte	7	6	5	4	3	2	1	0	
0	Operation Code (BEh)								
1	Reserved			Expected Sector Type			Reserved		
2	Starting Logical Block Address								
3									
4									
5									LSB
6	Transfer Length in Blocks								
7									
8									LSB
Flag Bits									
9	Synch Field	Header(s) Code		User Data	EDC & ECC	Error Flag(s)		Reserved	
10	Reserved					Sub-Channel Data Selection Bits			
11	Reserved								

The Expected Sector Type field is used to limit the amount of information returned to the Host. If the Requested Sector(s) do not match the specified type, the command will be terminated with a CHECK CONDITION. The Sector that does not match will not be transferred to the Host. The sense key *shall* be set to ILLEGAL MODE FOR THIS TRACK.

Implementer's Note: The Expected Sector Type is used to generate an error and terminate the transfer when the sectors found on the media, do not match the type desired. This field has NO control of the actual number of bytes transferred.

Table 94 - READ-CD, Expected Sector Type Field Definition

Expected Sector Type	Definition	Description
000b	Any Type (Mandatory)	No checking of the Sector Type will be performed. The device <i>shall</i> always terminate a command, at the sector where a transition between CD-Rom and CD-DA occurs.
001b	CD DA (Optional)	Only Red Book (CD-DA) sectors <i>shall</i> be allowed. An attempt to read any other format <i>shall</i> result in the reporting of an error.
010b	Mode 1 (Mandatory)	Only Yellow Book sectors which have a "user" data field of 2048 bytes <i>shall</i> be allowed. An attempt to read any other format <i>shall</i> result in the reporting of an error.
011b	Mode 2 (Mandatory)	Only Yellow Book sectors which have a "user" data field of 2336 bytes <i>shall</i> be allowed. An attempt to read any other format <i>shall</i> result in the reporting of an error.
100b	Mode 2 Form 1 (Mandatory)	Only Green Book sectors which have a "user" data field of 2048 <i>shall</i> be allowed. An attempt to read any other format <i>shall</i> result in the reporting of an error.
101b	Mode 2 Form 2 (Mandatory)	Only Green Book sectors which have a "user" data field of 2324 <i>shall</i> be allowed. An attempt to read any other format <i>shall</i> result in the reporting of an error. Note that the spare data is included in the user data making the size 2324+4= 2328.
110b - 111b		Reserved

See also, CD-ROM Sector Formats on page 73.

The Synch Field Bit, when set to one indicates that the Synch Field from the sector will be included in the data stream. Note that the data fields that are requested to be included in the data stream *shall* be contiguous. The Synch Field information (if selected) will be the first information in the data stream; all other fields will follow.

The Header(s) Code is an encoded field that indicates the Header / Subheader information to be placed in the data stream.

Table 95 - READ CD, Header(s) Code Field Definition

Header(s) Code	Definition	Description
00b	None	None of the header data <i>shall</i> be placed in the data stream.
01b	HdrOnly	Only the Mode 1 or Form 1 4-byte header will be returned in the data stream.
10b	SubheaderOnly	Only the Mode 2 Form 1 or 2 Subheader will be placed into the data stream.
11b	All Headers	Both the Header and Subheader will be placed in the data stream.

The User Data Flag, when set to one, indicates that the Data part of a CD Sector *shall* be returned in the data stream. When set to 1, the whole user data will be returned to the host. Note that the setting of the Mode Select Density Code does not apply to this command, and the physical user data will be returned. If the current track is an Audio Track then the Audio Data will be returned, else the normal CD-ROM data will be returned. The possible data lengths are 2048, 2336, 2328 and 2352.

The EDC and ECC Flag, when set to one, indicates that the EDC and ECC (L-EC) field *shall* be included in the data

stream. For Mode 1 CDs this will include the 8 bytes of pad data.

Error Flag(s) is an encoded field that indicates which (if any) of the C2 and/or Block Error data will be included in the data stream. All the field types are mandatory. If the drive does not support the C2 pointers (as reported in the Mode sense Capabilities page) the data returned *shall* be zero filled.

Table 96 - READ CD, Error Flag(s) Field Definition

Error Flags	Definition	Description
00b	None	No Error information will be included in the data stream.
01b	C2 Error Flag data	The C2 Error Flag (Pointer) bits (2352 bits or 294 bytes) will be included in the data stream. When the C2 Error pointer bits are included in the data stream, there will be one bit for each byte in error in the sector (2352 total). The bit ordering is from the most significant bit to the least significant bit in each byte. The first bytes in the sector will be the first bits/bytes in the data stream.
10b	C2 & Block Error Flags	Both the C2 Error Flags (2352 bits or 294 bytes) and the Block Error Byte will be included in the data stream. The Block Error byte is the OR of all the C2 Error Flag bytes. So that the data stream will always be an even number of bytes, the Block Error byte will be padded with a byte (undefined). The Block Error byte will be first in the data stream followed by the pad byte.
11b	Reserved	Reserved for future enhancement.

The Sub-Channel Data Selection bits indicate which CD Sub-Channel information is to be included in the data stream, the Q information and/or the “Raw” Sub-channel information (All eight channels, one byte from each of the small frames.) If the bit is set, then that Sub-channel data will be included in the data stream to the Host.

Table 97 - READ CD, Sub-channel Data Selection Field Definition

Sub-channel Data Selection	Definition	Description	Type
000b	No Sub-channel Data	No Sub-channel data will be transferred	Mandatory
001b	RAW	Raw Sub-channel data will be transferred	Optional
010b	Q	Q data will be transferred	Optional
011b	Reserved		
100b	R - W	R-W data will be transferred	Optional
101b - 111b	Reserved		

Support of Sub-channel data is optional. In the case of R-W the drive may return the data de-interleaved and error-corrected, RAW or padded with zeros depending on the R-W Supported and R-W de-interleaved and error-corrected bits in the CD-ROM capabilities and mechanical status page. Changing the DCR bit using Mode Select for page 1 (Read error recovery page) will affect error correction of subcode data. The inclusion of the sub-channel data will only be valid for Audio sectors.

If the Starting Logical Block Address is set to FFFFFFFFh and the **only** information requested to be placed in the data stream is the Sub-channel data and there is currently a PLAY AUDIO command in process, the actual address used will be from the current location (of the Play). If the drive is not playing audio, the drive will respond with a CHECK CONDITION with a sense key/ASC/ASCQ of 05h/B9h/00h (Play Not in Progress).

Table 98 - Formatted Q-subcode Data (A Total of 16 Bytes)

Byte	Description
0	Control (4 M.S. bits), ADR (4 L.S. bits)
1	Track number
2	Index number
3	Min
4	Sec
5	Frame
6	Reserved (00h)
7	AMin
8	Asec
9	AFrame
10	CRC* or 00h (hex)
11	CRC* or 00h (hex)
12	00h (pad)
13	00h (pad)
14	00h (pad)
15	00h (pad)

* CRC is optional

Table 99 - Number of Bytes Returned Based on Data Selection Field

Data to be transferred	Flag Bits	CD-DA	Mode 1	Mode 2 non XA	Mode 2 Form 1	Mode 2 Form 2
User Data	10h	2352	2048	2336	2048	2328
User Data + EDC/ECC	18h	(10h)	2336	(10h)	2336	(10h)
Header Only	20h	(10h)	4	4	4	4
Header Only + EDC/ECC	28h	(10h)	Illegal	Illegal	Illegal	Illegal
Header & User Data	30h	(10h)	2052	2340	Illegal	Illegal
Header & User Data + EDC/ECC	38h	(10h)	2344	(30h)	Illegal	Illegal
Sub Header Only	40h	(10h)	8	8	8	8
Sub Header Only + EDC/ECC	48h	(10h)	Illegal	Illegal	Illegal	Illegal
Sub Header & User Data	50h	(10h)	(10h)	(10h)	2056	2336
Sub Header & User Data + EDC/ECC	58h	(10h)	(10h)	(10h)	2344	(50h)
All Headers Only	60h	(10h)	12	12	12	12
All Headers Only + EDC/ECC	68h	(10h)	Illegal	Illegal	Illegal	Illegal
All Headers & User Data	70h	(10h)	(30h)	(30h)	2060	2340
All Headers & User Data + EDC/ECC	78h	(10h)	(30h)	(30h)	2340	2340
Sync & User Data	90h	(10h)	Illegal	Illegal	Illegal	Illegal
Sync & User Data + EDC/ECC	98h	(10h)	Illegal	Illegal	Illegal	Illegal
Sync & Header Only	A0h	(10h)	16	16	16	16
Sync & Header Only + EDC/ECC	A8h	(10h)	Illegal	Illegal	Illegal	Illegal
Sync & Header & User Data	B0h	(10h)	2064	2352	Illegal	Illegal
Sync & Header & User Data + EDC/ECC	B8h	(10h)	2344	(30h)	Illegal	Illegal
Sync & Sub Header Only	C0h	(10h)	Illegal	Illegal	Illegal	Illegal
Sync & Sub Header Only + EDC/ECC	C8h	(10h)	Illegal	Illegal	Illegal	Illegal
Sync & Sub Header & User Data	D0h	(10h)	(10h)	(10h)	Illegal	Illegal
Sync & Sub Header & User Data + EDC/ECC	D8h	(10h)	(10h)	(10h)	Illegal	Illegal
Sync & All Headers Only	E0h	(10h)	24	24	24	24
Sync & All Headers Only + EDC/ECC	E8h	(10h)	Illegal	Illegal	Illegal	Illegal
Sync & All Headers & User Data	F0h	(10h)	2064	2352	2072	2352
Sync & All Headers & User Data + EDC/ECC	F8h	(10h)	2352	(F0h)	2352	(F0h)
Repeat All Above and Add Error Flags	02h	294	294	294	294	294
Repeat All Above and Add Block & Error Flags	04h	296	296	296	296	296

The lengths of the data returned from the READ CD command vary based on the type of sector that is being read and the requested fields to be returned to the Host. Many combinations are possible, but most are not very useful. Table 99, "Number of Bytes Returned Based on Data Selection Field," on page 147 specifies how the drive responds to many of the requests possible. Requests for transfers not specified by this table *shall* not be supported and treated as Illegal. Illegal values will cause the command to be aborted with a CHECK Condition, Sense Key 05, ASC 24 (INVALID FIELD IN COMMAND PACKET).

The Values in () indicate that the amount of data is the same as the Flag byte setting specified by the contents of the parenthesis.

Values that are shaded are most useful to the host and *shall* return the number of bytes specified if supported.

See "Figure 11 - CD-ROM Sector Formats" on page 73 for a description of the data available for each sector type.

Table 100 - Recommended Sense Key, ASC and ASCQ for Read CD Command Errors

Sense Key	ASC	ASCQ	Description of Error
05	20		INVALID COMMAND OPERATION CODE
05	24		INVALID FIELD IN COMMAND PACKET
06	28		NOT READY TO READY TRANSITION
06	29		POWER ON, RESET OR BUS DEVICE RESET OCCURRED
02	04	00	LOGICAL DRIVE NOT READY - CAUSE NOT REPORTABLE
02	04	01	LOGICAL DRIVE NOT READY - IN PROGRESS OF BECOMING READY
02	04	02	LOGICAL DRIVE NOT READY - INITIALIZING COMMAND REQUIRED
02	04	03	LOGICAL DRIVE NOT READY - MANUAL INTERVENTION REQUIRED
02	06	00	NO REFERENCE POSITION FOUND (media may be upside down)
02	3A		MEDIUM NOT PRESENT
03	02		NO SEEK COMPLETE
05	21		LOGICAL BLOCK ADDRESS OUT OF RANGE
05	64		ILLEGAL MODE FOR THIS TRACK OR INCOMPATIBLE MEDIUM
05	00	11	PLAY OPERATION IN PROGRESS
0B	BF		LOSS OF STREAMING

The CD-DA audio data includes 16 bits of information for each channel, and will be formatted as follows when an audio track is read.

Table 101 - CD-DA (Digital Audio) Data Block Format

Bit Byte	7	6	5	4	3	2	1	0
Cell 1 (1st of 588)								
0	Left Channel (Lower Byte)							
	b7	b6	b5	b4	b3	b2	b1	b0
1	Left Channel Upper Byte							
	b15	b14	b13	b12	b11	b10	b9	b8
2	Right Channel (Lower Byte)							
	b7	b6	b5	b4	b3	b2	b1	b0
3	Right Channel Upper Byte							
	b15	b14	b13	b12	b11	b10	b9	b8
.								
.								
.								
2348	Left Channel (Lower Byte)							
	b7	b6	b5	b4	b3	b2	b1	b0
2349	Left Channel Upper Byte							
	b15	b14	b13	b12	b11	b10	b9	b8
2350	Right Channel (Lower Byte)							
	b7	b6	b5	b4	b3	b2	b1	b0
2351	Right Channel Upper Byte							
	b15	b14	b13	b12	b11	b10	b9	b8

If the CD-ROM Drive does not support the CD-DA Stream-Is-Accurate capability (See "10.8.6.4 CD-ROM Capabilities and Mechanical Status Page" on page 118) then the Digital Audio data must be read as a continuous stream. If while streaming the drive must stop, there will be a non-recoverable error generated (Sense Key 0Bh ABORTED Command, Sense Code BFh LOSS OF STREAMING). This is due to the 1 second uncertainty of the address (There is no header in CD-DA Data). Reissuing the command may not return exactly the same data as the previous try. When the drive supports the Stream Accurate capability, there will be no error, only some time delay for rotational latency.

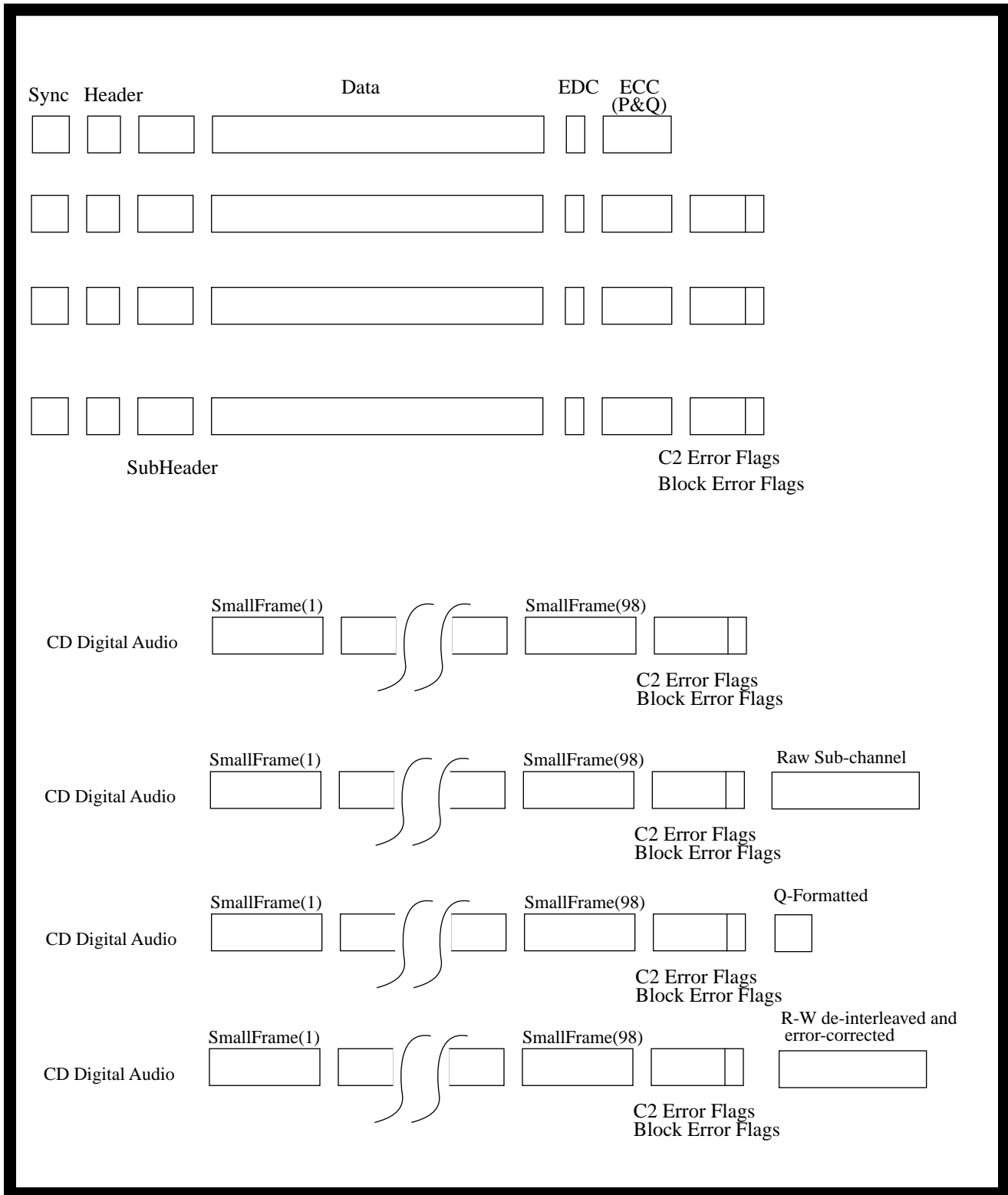

Figure 13 - Read CD Data Stream Order

10.8.15.1 Description of Sub-channels R-W

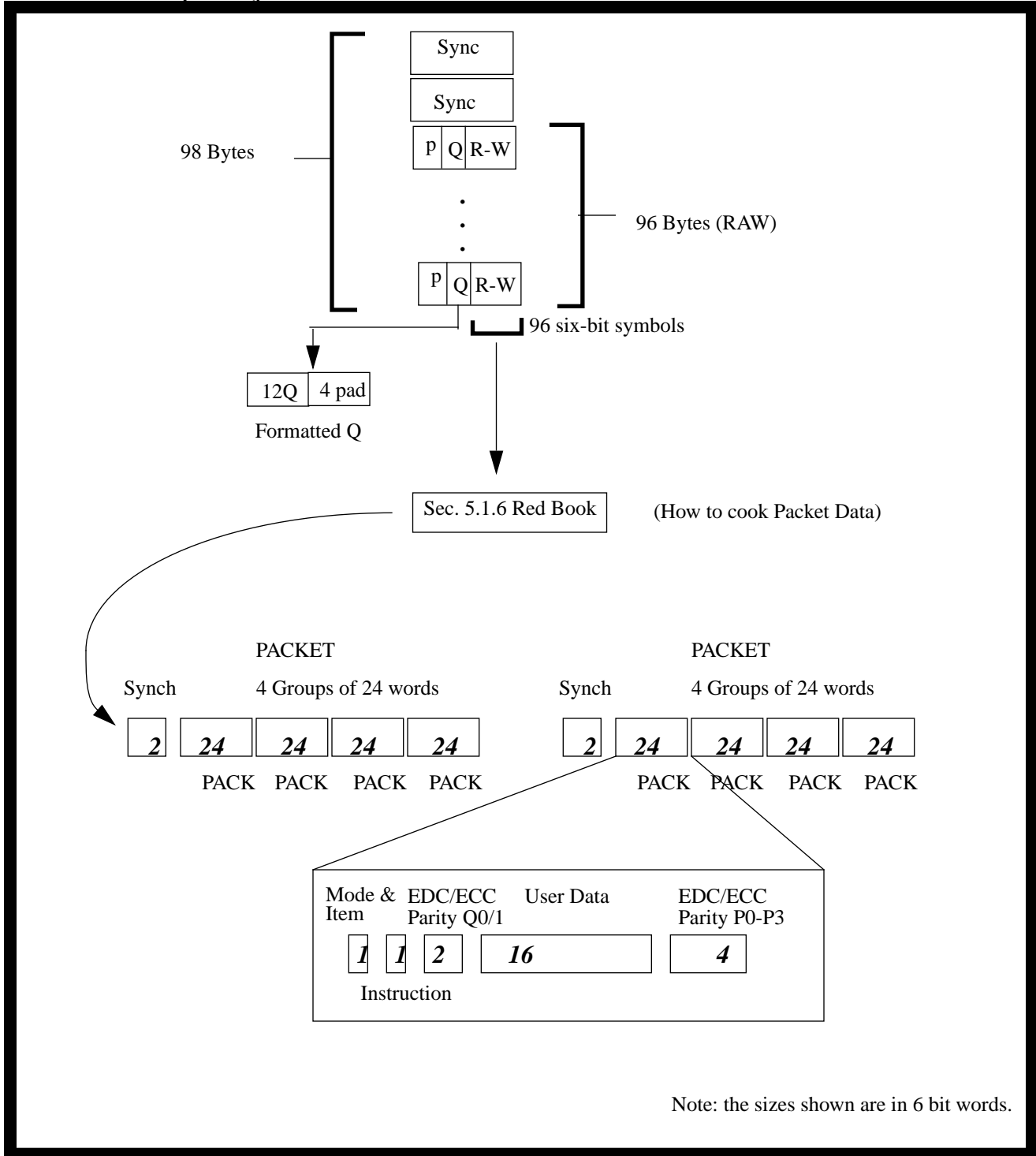

Figure 14 - Read CD Sub-channel, R-W (100b)

Table 102 - R-W Raw

Bit Byte	7	6	5	4	3	2	1	0
0	P2W (0)							
1	P2W (1)							
...	...							
95	P2W (95)							

R-W Raw is returned in the format and order found on the media. It is the responsibility of the device driver to deinterleave and perform error detection and correction on the RAW data to make it usable to higher level applications.

Table 103 - R-W De-Interleaved & Error Corrected

Bit Byte	7	6	5	4	3	2	1	0
0	P	Q	PACK1(0)					
1	P	Q	PACK1(1)					
...	...							
23	P	Q	PACK1(23)					
24	P	Q	PACK2(0)					
25	P	Q	PACK2(1)					
...	...							
47	P	Q	PACK2(23)					
48	P	Q	PACK3(0)					
49	P	Q	PACK3(1)					
...	...							
71	P	Q	PACK3(23)					
72	P	Q	PACK4(0)					
73	P	Q	PACK4(1)					
...	...							
95	P	Q	PACK4(23)					

Drives that can not return P or Q code with PACK data will return 0 in the unsupported P or Q bits. Each PACK is generated after 2 contiguous Sub Channel data frames consisting of 24 bytes with 6 bits of PACK data per byte. Each 96 byte Packet consists of 4 PACKs of 24 bytes each.

The basic RAW format is shown in "Figure 14 - Read CD Sub-channel, R-W (100b)" on page 151. The data is synchronized with the subcode synch patterns S0 and S1. Each group of 6 bits (R-W) is called a "symbol". The symbol following the synchs S0 and S1 is the first symbol of the first pack in a packet. The packs following the sync bytes in R~W data must be from the same block and in chronological order.

To guard the data in the subcoding channels R-W, a (24,20) Reed-Solomon Error Correction Code is used. To improve the burst error correction capability, eight-way interleaving is added to this error correction system.

The first two symbols in a pack have additional protection with a (4,2) Read-Solomon Error Correction Code. The first symbol of a pack contains a mode-switch of 3 bits and a 3-bit subdivision of mode, called "item". The defined mode-item

combinations are defined in the following table.

Table 104 - Sub-channel R-W, Allowed Mode/Item Combinations

Mode	Item	Description
000b (0d)	000b (0d)	The ZERO mode
001b (1d)	000b (0d)	The LINE GRAPHICS mode
	001b (1d)	The TV GRAPHICS mode
111b (7d)	000b (0d)	The USER mode
All Others		Reserved for future use

The R-W information is returned as part of the “raw” sub-channel data. The lower 6 bits of each of the bytes contain the R-W data. This data follows the format shown in *Figure 14 - Read CD Sub-channel, R-W (100b)* on page 151. If the Q information needs to be taken from the raw data, then it *shall* be deinterleaved according the Red book formats.

Intentionally Left Blank

10.8.16 READ CD MSF Command

The READ CD command (Family) provides one standard, universal way of accessing CD data. Rather than breaking the types of data into several related commands, this command is generic to all CD data types.

This command returns any of the CD data streams, including the headers, EDC and ECC, ROM data and CD-DA data. Each type of data is enabled via the use of flags. These flags indicate which information from the CD is to be returned in the data stream. If a flag is cleared, then that particular information will not be returned. If all the flags are cleared, no data will be returned to the host and this condition is not treated as an error.

Table 105 - READ CD MSF Command

Bit Byte	7	6	5	4	3	2	1	0
0	Operation code (B9h)							
1	Reserved			Expected Sector Type			Reserved	
2	Reserved							
3	Starting M Field							
4	Starting S Field							
5	Starting F Field							
6	Ending M Field							
7	Ending S Field							
8	Ending F Field							
9	Flag Bits							
	Synch Field	Header(s) Code		User Data	EDC & ECC	Error flag(s)		Reserved
10	Reserved					Sub-Channel Data Selection Bits		
11	Reserved							

The Starting M field, the Starting S field, and the Starting F field specify the absolute MSF address at which the Read operation *shall* begin. The Ending M field, the Ending S field, and the Ending F field specify the absolute MSF address where the Read operation *shall* end. All contiguous sectors between the starting and the ending MSF address *shall* be read.

A starting MSF address equal to an ending MSF address prevents a read operation. This *shall* not be considered an error. If the starting MSF address is greater than the ending MSF address, the command *shall* be terminated with CHECK CONDITION status. The sense key *shall* be set to ILLEGAL REQUEST.

If the starting address is not found, or if a not ready condition exists, the command *shall* be terminated with CHECK CONDITION status.

See "10.8.15 READ CD Command" on page 143 for a description of Expected User Data Type, Flag Bits and Sub-channel Data Selection Bits.

Table 106 - Recommended Sense Key, ASC and ASCQ for Read CD MSF Command Errors

Sense Key	ASC	ASCQ	Description of Error
05	20		INVALID COMMAND OPERATION CODE
05	24		INVALID FIELD IN COMMAND PACKET
06	28		NOT READY TO READY TRANSITION
06	29		POWER ON, RESET OR BUS DEVICE RESET OCCURRED
02	04	00	LOGICAL DRIVE NOT READY - CAUSE NOT REPORTABLE
02	04	01	LOGICAL DRIVE NOT READY - IN PROGRESS OF BECOMING READY
02	04	02	LOGICAL DRIVE NOT READY - INITIALIZING COMMAND REQUIRED
02	04	03	LOGICAL DRIVE NOT READY - MANUAL INTERVENTION REQUIRED
02	06	00	NO REFERENCE POSITION FOUND (media may be upside down)
02	3A		MEDIUM NOT PRESENT
03	02		NO SEEK COMPLETE
05	21		LOGICAL BLOCK ADDRESS OUT OF RANGE
05	64		ILLEGAL MODE FOR THIS TRACK OR INCOMPATIBLE MEDIUM
05	00	11	PLAY OPERATION IN PROGRESS
0B	BF		LOSS OF STREAMING

10.8.17 READ HEADER Command

The READ HEADER command requests that the device return the CD-ROM Data Block Address Header of the requested logical block.

Table 107 - READ HEADER Command

Bit Byte	7	6	5	4	3	2	1	0
0	Operation code (44h)							
1	Reserved						MSF	Reserved
2	MSB Logical Block Address							
3								
4								
5								
6	Reserved							
7	MSB Allocation Length							
8								
9	Reserved							
10	Reserved							
11	Reserved							

See "8.6 CD-ROM Address Reporting Formats (MSF bit)" on page 78 for a description of the MSF bit.

The Logical Block Address field specifies the logical block at which the read header operation *shall* begin.

See the READ (10) command for exception handling.

The READ HEADER data format below defines the format for the returned CD-ROM data block address header of the requested logical block.

Table 108 - READ HEADER LBA Data Format

Bit Byte	7	6	5	4	3	2	1	0
0	CD-ROM Data Mode							
1	Reserved							
2	Reserved							
3	Reserved							
4	MSB Absolute CD-ROM Address							
5								
6								
7								

Table 109 - READ HEADER MSF Data Format

Bit Byte	7	6	5	4	3	2	1	0
0	CD-ROM Data Mode							
	0				ADR			
1	Reserved							
2	Reserved							
3	Reserved							
4	Reserved							
5	M							
6	S							
7	F							

The CD-ROM Data Mode field specifies the CD-ROM data mode of the logical blocks in this sector of data. The values in this field are defined in "Table 110 - CD-ROM Data Mode Codes" on page 158.

Table 110 - CD-ROM Data Mode Codes

CD-ROM Data Mode	User Data Field Contents (2048 Bytes)	Auxiliary Field Contents (288 bytes)
00h	All bytes zero	All bytes zero
01h	User data	L-EC symbols
02h	User data	User data
03h - FFh	Reserved	Reserved

If the MSF bit is zero, the Absolute Address field gives the logical block address of the first logical block in the physical sector where the data for the requested logical block address is found. If the MSF bit is one, the Absolute Address field gives the MSF address of the sector where the data for the requested logical block address is found.

Table 111 - Recommended Sense Key, ASC and ASCQ for Read Header Command Errors

Sense Key	ASC	ASCQ	Description of Error
05	20		INVALID COMMAND OPERATION CODE
05	24		INVALID FIELD IN COMMAND PACKET
06	28		NOT READY TO READY TRANSITION
06	29		POWER ON, RESET OR BUS DEVICE RESET OCCURRED
02	04	00	LOGICAL DRIVE NOT READY - CAUSE NOT REPORTABLE
02	04	01	LOGICAL DRIVE NOT READY - IN PROGRESS OF BECOMING READY
02	04	02	LOGICAL DRIVE NOT READY - INITIALIZING COMMAND REQUIRED
02	04	03	LOGICAL DRIVE NOT READY - MANUAL INTERVENTION REQUIRED
02	06	00	NO REFERENCE POSITION FOUND (media may be upside down)
02	3A		MEDIUM NOT PRESENT
03	02		NO SEEK COMPLETE
05	21		LOGICAL BLOCK ADDRESS OUT OF RANGE
05	64		ILLEGAL MODE FOR THIS TRACK OR INCOMPATIBLE MEDIUM

Intentionally Left Blank

10.8.18 READ SUB-CHANNEL Command

The READ SUB-CHANNEL command requests that the ATAPI CD-ROM Drive return the requested sub-channel data plus the state of play operations.

Table 112 - READ SUB-CHANNEL Command

Bit Byte	7	6	5	4	3	2	1	0
0	Operation code (42h)							
1	Reserved						MSF (Mandatory)	Reserved
2	Reserved	SubQ (Mandatory)	Reserved					
3	Sub-channel Data Format							
4	Reserved							
5	Reserved							
6	Track Number							
7	MSB		Allocation Length				LSB	
8								
9	Reserved							
10	Reserved							
11	Reserved							

Sub-channel data returned by this command may be from the last appropriate sector encountered by a current or previous media accessing operation. When there is no current play operation, the ATAPI CD-ROM Drive may access the media to read the sub-channel data. The ATAPI CD-ROM Drive is responsible for ensuring that the data returned are current and consistent.

See "8.6 CD-ROM Address Reporting Formats (MSF bit)" on page 78 for a description of the MSF bit. Support for the MSF bit is mandatory.

The sub Q bit set to one requests that the ATAPI CD-ROM Drive return the Q sub-channel data. The sub Q bit set to zero requests that no sub-channel data be returned. This *shall* not be considered an error. Support for the SubQ bit is mandatory. When the sub Q bit is Zero, only the Sub-Channel data header is returned.

Table 113 - Sub-channel Data Header Format

Bit Byte	7	6	5	4	3	2	1	0
Sub Channel Data Header								
0	Reserved							
1	Audio Status							
2	Sub-channel Data Length							
3								

The sub-channel data format field specifies the returned sub channel data. If this field is 01h, 02h or 03h, the requested sub-Q data item is returned.

Table 114 - Sub-channel Data Format Codes

Format Code	Returned data	Support Requirement
00h	Reserved	Reserved
01h	CD-ROM current position	Mandatory
02h	Media catalogue number (UPC/bar code)	Mandatory
03h	Track international standard recording code (ISRC)	Mandatory
04h - EFh	Reserved	
F0h - FFh	Vendor-specific	Optional

The track number field specifies the track number from which the ISRC code is transferred. This field *shall* have a value from 01h to 63h (99d), and is valid only when the sub-channel data format is 03h. If this field is nonzero for all sub-channel data formats other than 03h the drive will terminate the command with a check condition (INVALID REQUEST / INVALID FIELD IN COMMAND PACKET).

10.8.18.1 CD-ROM Current Position Data Format

Table 115 - CD-ROM Current Position Data Format (Format Code 01h)

Bit Byte	7	6	5	4	3	2	1	0									
Sub Channel Data Header																	
0	Reserved																
1	Audio Status																
2	Sub-channel Data Length																
3	MSB							LSB									
CD-ROM Current Position Data Block																	
4	Sub Channel Data Format Code (01h)																
5	ADR				Control												
6	Track Number																
7	Index Number																
8	Absolute CD-ROM Address																
9	See "Table 27 - MSF Address Format" on page 78																
10																	
11									MSB							LSB	
12	Track Relative CD-ROM Address																
13	MSB																
14																	
15									MSB							LSB	
15									MSB								LSB

The Audio Status field indicates the status of play operations. The audio status values are defined in "Table 116 - Audio Status Codes" on page 163. Audio status values 13h and 14h return information on previous audio operations; they are returned only once after the condition has occurred. If another play operation is not requested, the audio status returned for subsequent READ SUB-CHANNEL commands is 15h.

Table 116 - Audio Status Codes

Status	Description
00h	Audio status byte not supported or not valid
11h	Play operation in progress
12h	Play operation paused
13h	Play operation successfully completed
14h	Play operation stopped due to error
15h	No current audio status to return

The Sub-channel Data Length specifies the length in bytes of the following sub-channel data block. A sub-channel data length of zero indicates that no sub-channel data block is included in the returned data. Sub-channel data length does not include the sub channel header.

The Sub-Q Channel Data Block consists of control data (bytes 4 - 5), current position data (bytes 6 - 15) and identification data (bytes 16 - 47). The control data and current position data is obtained from the Q sub-channel information of the current block. Identification data may be reported that was obtained from a previous block. If identification data is reported, the data *shall* be valid for the sector addressed by the current position data.

1. If an play operation is proceeding in the background, position data for the last sector played *shall* be reported.
2. In other cases, for instance after a READ command, the ATAPI CD-ROM Drive may either report position data for the last sector processed for that operation or may report position data from the sector at the current read head position.

The ADR field gives the type of information encoded in the Q sub-channel of this block, as shown in the following table.

Table 117 - ADR Sub-channel Q Field

ADR code	Description
0h	Sub-channel Q mode information not supplied
1h	Sub-channel Q encodes current position data (i.e. track, index, absolute address, relative address)
2h	Sub-channel Q encodes media catalogue number
3h	Sub-channel Q encodes ISRC
4h - Fh	Reserved

Table 118 - Sub-channel Q Control Bits

Bit	Equals zero	Equals one
0	Audio without pre-emphasis	Audio with pre-emphasis
1	Digital copy prohibited	Digital copy permitted
2	Audio track	Data track
3	Two-channel audio	Four-channel audio

The Track Number field specifies the track from which ISRC data is read. This field must have a value between 01h and 63h and is valid only when the sub-channel data format field is 03h. In this case, the ATAPI CD-ROM Drive returns ISRC data for this track.

The Index Number specifies the index number in the current track.

The Absolute CD-ROM Address field gives the current location relative to the logical beginning of the media. If the MSF bit is zero, this field is a logical block address. If the MSF bit is one, this field is an absolute MSF address.

The Track Relative CD-ROM Address field gives the current location relative to the logical beginning of the current track. If the MSF bit is zero, this field is a track relative logical block address. (If the current block is in the pre-gap area of a track, this will be a negative value, expressed as a two's-complement number.) If the MSF bit is one, this field is the relative MSF address from the Q sub-channel.

10.8.18.2 Media Catalogue Number Data Format

A Media Catalogue Valid (MCVal) bit of one indicates that the media catalogue number field is valid. A MCVal bit of zero indicates that the media catalogue number field is not valid.

The Media Catalogue Number field contains the identifying number of this media according to the uniform product code values (UPC/EAN bar coding) expressed in ASCII. Non-zero values in this field are controlled by the Uniform Product Code Council¹) and the European Article Number Council². A value in this field of all ASCII zeros indicates that the media catalog number is not supplied.

If media catalogue number data is found, the MCVal bit is set to one. If MCN data is not detected, the MCVal bit is set to zero to indicate the Media Catalogue Number field is invalid.

Media catalogue number data returned by this command with sub-channel data format field code 02h may be from any block that has UPC bar code Q sub-channel data. (This code is constant anywhere in every applicable disc.)

The CD-ROM Drive may either return the UPC information that it has previously read (Cached data) or may scan for the information. As the UPC is only guaranteed to be contained in 1 out of 100 sectors and errors may be encountered, the time required to return the UPC data could be several seconds.

Table 119 - Media Catalogue Number Data Format (Format Code 02h)

Bit Byte	7	6	5	4	3	2	1	0	
Sub Channel Data Header									
0	Reserved								
1	Audio Status								
2	MSB		Sub-channel Data Length				LSB		
3									
Media Catalogue Number Data Block									
4	Sub Channel Data Format Code (02h)								
5	Reserved								
6	Reserved								
7	Reserved								
8	MCVal	Reserved							
9	Media Catalogue Number (UPC/Bar Code) (See "Table 120 - UPC Format" on page 166)								
23									

1. The Uniform Product Code Council is located at 8163 Old Yankee Road, Suite J, Dayton, Ohio 45459.
2. The European Article Number Council is located at Rue des Colonies, 54-BTE8, 1000 Brussels, Belgium.

Table 120 - UPC Format

Bit Byte	7	6	5	4	3	2	1	0
8	MCVal	Reserved						
9	N1 (Most significant)							
10	N2							
11	N3							
12	N4							
13	N5							
14	N6							
15	N7							
16	N8							
17	N9							
18	N10							
19	N11							
20	N12							
21	N13							
22	Zero							
23	AFrame (Binary)							

N1 through N13 *shall* be retrieved from the Q channel in mode 2. The data *shall* be encoded as ASCII characters (i.e. if N1 of the UPC is 01bcd, then N1 of the above field *shall* be 49d or 31h).

10.8.18.3 Track International Standard Recording Code Data Format

The Track ISRC field contains the identifying number of this media according to the ISRC standards (DIN-31-621).

Table 121 - Track International Standard Recording Code Data Format

Bit Byte	7	6	5	4	3	2	1	0
Sub Channel Data Header								
0	Reserved							
1	Audio Status							
2	Sub-channel Data Length							
3								
Track ISRC Data Block								
4	Sub Channel Data Format Code (03h)							
5	ADR (03)				Control			
6	Reserved							
7	Reserved							
8	TCVal	Reserved						
9	Track International Standard Recording Code (ISRC)							
23								

If ISRC data is detected, the TCVal bit is set to one. If ISRC data is not detected, the TCVal bit is set to zero to indicate the ISRC field is invalid.

Track ISRC data returned by this command with sub-channel data format field 03h may be from any block in the specified track that has ISRC data. When ADR field is 3 (0011), it is used to assign a unique number to an audio track. This is done by means of the ISRC which is 12 characters long (represented by I1 to I12.) The ISRC can only change immediately after the TNO has been changed.

Table 122 - Raw ISRC Format on the CD-ROM Disc

S0, S1	Control	ADR	I1 I2	I3 I4 I5	00	I6 I7 I8 I9 I10 I11 I12	zero	A Frame	CRC	
		3	ISRC 60 bits							

00: These 2 bits are zero.

zero: These 4 bits are zero.

I1, I2 are the country code; I3, I4, I5 are the owner code; I6, I7 are the year of recording; I8, I9, I10, I11, I12 are the serial number of the recording. AFrame is the absolute frame number.

Note: The information returned for the ISRC may be returned as is from the media, or in some cases it may be converted to ASCII. It is recommended that the drive convert the information to ASCII.

Table 123 - ISRC Format of Data Returned to Host

Bit Byte	7	6	5	4	3	2	1	0
8	TCVal	Reserved						
9				I1 (Country Code)				
10				I2				
11				I3 (Owner Code)				
12				I4				
13				I5				
14	Note: The shaded Bits are used if the drive converts the data returned to ASCII			I6 (Year of Recording)				
15				I7				
16				I8 (Serial Number)				
17				I9				
18				I10				
19				I11				
20				I12				
21				Zero				
22	AFrame							
23	Reserved							

Table 124 - Recommended Sense Key, ASC and ASCQ for Read Sub-channel Command Errors

Sense Key	ASC	ASCQ	Description of Error
05	20		INVALID COMMAND OPERATION CODE
05	24		INVALID FIELD IN COMMAND PACKET
06	28		NOT READY TO READY TRANSITION
06	29		POWER ON, RESET OR BUS DEVICE RESET OCCURRED
02	04	00	LOGICAL DRIVE NOT READY - CAUSE NOT REPORTABLE
02	04	01	LOGICAL DRIVE NOT READY - IN PROGRESS OF BECOMING READY
02	04	02	LOGICAL DRIVE NOT READY - INITIALIZING COMMAND REQUIRED
02	04	03	LOGICAL DRIVE NOT READY - MANUAL INTERVENTION REQUIRED
02	06	00	NO REFERENCE POSITION FOUND (media may be upside down)
02	3A		MEDIUM NOT PRESENT
03	02		NO SEEK COMPLETE
05	21		LOGICAL BLOCK ADDRESS OUT OF RANGE
05	64		ILLEGAL MODE FOR THIS TRACK OR INCOMPATIBLE MEDIUM
05	00	11	PLAY OPERATION IN PROGRESS
05	00	12	PLAY OPERATION PAUSED
05	00	13	PLAY OPERATION SUCCESSFULLY COMPLETED
05	00	14	PLAY OPERATION STOPPED DUE TO ERROR
05	00	15	NO CURRENT AUDIO STATUS TO RETURN

10.8.18.4 Caching of Sub-Channel Data

- | Sub-channel Q data *shall* be cached by the drive while playing audio. This is necessary so that the Read Sub-channel or Read CD commands can access the Sub-Channel Q data while executing an immediate command. The device *shall* generate an error if the data is not in the cache.
- | Read Sub-channel will return the “Current” data, while Read CD will return the specified data and remove any previous (older) data from the cache.
- | Using “FFFFFFFF” on Read CD will work just like Read Sub-channel.

10.8.19 READ TOC Command

The READ TOC command requests that the ATAPI CD-ROM Drive transfer data from the table of contents to the Host Computer. Some drives will cache the TOC data and will be able to return it during an Play command. Drives that do not cache the data will generate an error and not complete the command.

Table 125 - READ TOC Command

Bit Byte	7	6	5	4	3	2	1	0
0	Operation code (43h)							
1	Reserved						MSF (Mandatory)	Reserved
2	Reserved				Format			
3	Reserved							
4	Reserved							
5	Reserved							
6	Starting Track / Session Number							
7	MSB		Allocation Length				LSB	
8								
9	Format		Reserved					
10	Reserved							
11	Reserved							

See "8.6 CD-ROM Address Reporting Formats (MSF bit)" on page 78 for a description of the MSF bit. Support for the MSF bit is mandatory.

To identify the multi-session CD TOC, the most significant 2 bits of the byte at offset 9 (Format) have been assigned to identify this information. For handling multi-session and/or the Kodak PhotoCD, format 01b can be used. For drives that do not support multi-session, the First session number should be equal to the Last session number in the returned TOC information. Format field definition: When Format in Byte 2 is zero, then Byte 9 is used. Other values for this field are reserved for definition in MMC.

Note: The Format field in Byte 9 is a vendor-specific area and will be removed in subsequent versions of this specification. Functionality is moving to Byte 2.

00b Mandatory	This mode is a backward compatible mode where the starting track field specifies the starting track number for which the data <i>shall</i> be returned. If this value is zero, the table of contents data <i>shall</i> begin with the first track on the medium. The data are returned in contiguous ascending track number order.
01b Mandatory	Multi-session mode and returns the first session number, last session number and last session address. In this format the Starting Track is reserved.
10b Mandatory	Returns all Sub-channel Q data in the lead in (TOC) area, starting from a specified session number as specified in the Session Number Field. In this mode, the drive will support Q Subcode Point field values of A0h, A1h, A2h; Track Numbers of B0h, B1h, B2h, B3h, B4h and C0h.
11b	Reserved

The Starting Track Field specifies the starting track number for which the TOC data will be returned. The data is re-

turned in contiguous ascending order. Valid values for the starting track field are 0h to 63h. A value of AAh requests that the starting address of the lead out area be returned. If this value is zero, the table of contents data will begin with the first track on the disc.

If the starting track field is not valid for the currently installed medium, the command *shall* be terminated with CHECK CONDITION status. The sense key *shall* be set to ILLEGAL REQUEST and the additional sense code set to INVALID FIELD IN COMMAND PACKET.

NOTE The maximum TOC data length possible on currently available CD-ROM media is 804 bytes, or 100 TOC track descriptors.

Table 126 - Read TOC Data Format (With Format Field = 00b)

Bit Byte	7	6	5	4	3	2	1	0	
0	TOC Data Length							MSB	
1								LSB	
2	First Track Number								
3	Last Track Number								
TOC Track Descriptors									
0	Reserved								
1	ADR				Control				
2	Track Number								
3	Reserved								
4	Absolute CD-ROM Address								
5	See "Table 27 - MSF Address Format" on page 78								
6									
7	MSB								
								LSB	

The TOC Data Block contains a four-byte header followed by zero or more TOC track descriptors.

The TOC Data Length specifies the length in bytes of the following TOC data that is available to be transferred to the Host. The TOC Data Length Value does not include the TOC Data Length field itself.

The First Track Number field indicates the first track number in the table of contents. Valid track numbers are from 01d to 99d (63h).

The Last Track Number field indicates the last track number in the table of contents before the lead-out track number.

The First Track Number is not required to be one. A disc may start at any valid track number. The track numbers between the First Track Number and the Last Track Number are required to be in contiguous ascending order, except for the lead-out track.

The ADR field gives the type of information encoded in the Q sub-channel of the block where this TOC entry was found. The possible ADR values are defined in "Table 117 - ADR Sub-channel Q Field" on page 163.

The Control field indicates the attributes of the track. The possible Control field values are defined in "Table 133 - Values for Control Field in Sub-channel Q" on page 176.

The Track Number field indicates the track number for which the data in the TOC track descriptor is valid. A track number of 0AAh indicates that the track descriptor is for the start of the lead-out area.

The Absolute CD-ROM Address contains the address of the first block with user information for that track number as read from the table of contents. If the MSF bit in the READ TOC is zero, the absolute CD-ROM address field contains a logical block address. If the MSF bit is one, the absolute CD-ROM address field contains an MSF address.

The Starting Logical Block Address Value recovered from the TOC has a tolerance of zero for data tracks and plus or minus 75 CD sectors for audio tracks. This tolerance is multiplied by a factor dependent on the logical block length.

Table 127 - Read TOC Data Format (With Format Field = 01b)

Bit Byte	7	6	5	4	3	2	1	0	
0	MSB							TOC Data Length (0Ah)	
1								LSB	
2	First Session Number								
3	Last Session Number								
TOC Track Descriptors									
0	Reserved								
1	ADR				Control				
2	First Track Number in Last Session								
3	Reserved								
4	MSB								
5	Absolute CD-ROM Address of First Track in Last Session								
6	See "Table 27 - MSF Address Format" on page 78								
7								LSB	

For Format field 10b, the drive should return TOC data for Q-subcode mode (ADR field) 1 and 5 (Except mode 5, point 1 through 40) in the lead in area.

The First Session Number is equal to the Last Session Number for single session discs or if the drive does not support multi-session discs.

The TOC Data Length *shall* be 10 (0Ah).

Table 128 - Read TOC Data Format (With Format Field = 10b)

Bit Byte	7	6	5	4	3	2	1	0
0	MSB TOC Data Length (2 + (11 * The number of Descriptors returned))							
1	LSB							
2	First Session Number							
3	Last Session Number							
TOC Track Descriptors								
0	Session Number							
1	ADR				Control			
2	TNO (0)							
3	Point							
4	Byte 3 or Min							
5	Byte 4 or Sec							
6	Byte 5 or Frame							
7	Byte 6 or Zero							
8	Byte 7 or PMin							
9	Byte 8 or PSec							
10	Byte 9 or PFrame							

See Table 131, "Lead in Area (TOC), Sub-channel Q formats," on page 175 and section 10.8.19.2 on page 177 for a detailed description of bytes 2-10 above.

The returned TOC data of a multi-session disc is arranged in ascending order of the session number. The TOC data within a session is arranged in the order of Q Subcode Point Field value of A0h, A1h, A2h; Track Numbers B0h, B1h, B2h, B3h, B4h and C0h.

The TOC data returned shall be sorted according to the following rules:

1. Each session of a multisession disk shall be returned independently. No mixing of any of the pointers from each session shall occur.
2. The first TOC entries shall be the A0, A1, A2h pointers from the session. Note that in many cases these pointers are placed at the end of the actual TOC data on the media.
3. Following the Ax pointers will be all the Track Pointer entries.
4. Last will be any Bx, Cx or other reserved value pointers.

Table 129 - TOC Track Descriptors

Byte	Action	Description
Byte 0	Return a hex value	Session Number
Byte 1	No conversion, return as is	ADR / Cntrl
Byte 2	0	Track (TOC = 0)
Byte 3	If 0-99, then convert to hex	Point
Bytes 4 - 6	Conversion based on Point	MSF Field
Point 00-99	Value should be 00h	NRA Skip Values ORP / App Code Reserved
Point A0h - AFh	Value should be 00h	
Point B0h	Convert to hex	
Point B1h - BFh	Convert to hex	
Point C0	No Conversion	
Point C1 - FFh	No Conversion	
Byte 7	Conversion based on Point	ZERO Field
Point 00h - AFh	Value should be 00h	# Pntrs / Skip Reserved
Point B0h - BFh	Convert to Hex	
Point C0h - FFh	No Conversion	
Bytes 8 - 10	Conversion based on Point	ZERO Field
Point 00 - 99	Convert to hex	Track Start
Point A0h	Convert PMIN to hex, PSEC is retruned as is	1st / Last / Start LO
Point A1h - AFh	Convert to hex	1st / Last / Start LO
Point B0h	Convert to hex	Lead Out Max
Point B1h - BFh	Convert to hex	Skip Values
Point C0h	Convert to hex	ORP / App Code
Point C1h - FFh	No conversion	Reserved

Table 130 - Recommended Sense Key, ASC and ASCQ for Read TOC Command Errors

Sense Key	ASC	ASCQ	Description of Error
05	20		INVALID COMMAND OPERATION CODE
05	24		INVALID FIELD IN COMMAND PACKET
06	28		NOT READY TO READY TRANSITION
06	29		POWER ON, RESET OR BUS DEVICE RESET OCCURRED
02	04	00	LOGICAL DRIVE NOT READY - CAUSE NOT REPORTABLE
02	04	01	LOGICAL DRIVE NOT READY - IN PROGRESS OF BECOMING READY
02	04	02	LOGICAL DRIVE NOT READY - INITIALIZING COMMAND REQUIRED
02	04	03	LOGICAL DRIVE NOT READY - MANUAL INTERVENTION REQUIRED
02	06	00	NO REFERENCE POSITION FOUND (media may be upside down)
02	3A		MEDIUM NOT PRESENT
02	57		UNABLE TO RECOVER TABLE OF CONTENTS
05	00	11	PLAY OPERATION IN PROGRESS

10.8.19.1 Sub-channel Q TOC information

Table 131 - Lead in Area (TOC), Sub-channel Q formats

S0,S1	Control / ADR	TNO	Point	Min	Sec	Frame	Zero	Pmin	PSec	PFrame	CRC x16+x12 +x5+1	
	4/6	1	00	01-99	00 (Absolute time is allowed)			00	Start position of track			
	4/6	1	00	A0	00 (Absolute time is allowed)			00	First Track num	Disc Type	00	
	4/6	1	00	A1	00 (Absolute time is allowed)			00	Last Track num	00	00	
	4/6	1	00	A2	00 (Absolute time is allowed)			00	Start position of the Lead-out area			
	4/6	5	00	B0	Start time of next possible program in the Recordable Area of the Hybrid Disc			# of pointers in Mode 5	Maximum start time of the outermost Lead Out area in the Recordable Area of the Hybrid Disc			
	4/6	5	00	B1	00	00	00	00	# of Skip Interval Pointers (N<=40)	# of Skip Track Pointers (N<=21)	00	
	4/6	5	00	B2-B4	Skip #	Skip #	Skip #	Skip #	Skip #	Skip #	Skip #	
	4/6	5	00	01-40	Ending time for the interval that should be skipped			Reserved	Start time for interval that should be skipped on playback			
	4/6	5	00	C0	Optimum recording power	Applica-tion Code	Reserved	Reserved	Start time of the first Lead In Area of the Hybrid Disc			

Point

The Point field defines various types of information:

- 01-99 Track number references
- A0 First Track number in the program area
- A1 Last Track number in the program area
- A2 Start location of the Lead-out area
- B0 Used to identify a Hybrid Disc (Photo CD)
Contains start time of next possible program area
- B1 Number of Skip Interval Pointers & Skip Track assignments
- 01-40 Skip Interval Pointers
- B2-B4 Skip Track Assignment Pointers
- C0 Start time of first Lead In area of Hybrid Disc
This only exists in the first Lead In area

Disc Type Byte

This byte contains a definition of the type of disc

- 00h CD-DA or CD-ROM with first track in Mode 1
- 10h CD-I disc
- 20h CD-ROM XA disc with first track in Mode 2

Table 132 - Bit Definitions for the Control Field in Sub-channel Q

Control Field	Definition
0 0 x 0	2 Audio without Pre-emphasis
0 0 x 1	2 Audio with Pre-emphasis
0 x 0 x	Copy Prohibited
0 x 1 x	Copy Permitted
0 1 x 0	Digital Data
1 x x x	Broadcast Data (TBD)

Table 133 - Values for Control Field in Sub-channel Q

Control Field value	Description
00h	Copy Prohibited, 2 Audio with out pre-emphasis
01h	Copy Prohibited, 2 Audio with pre-emphasis
02h	Copy Permitted, 2 Audio with out pre-emphasis
03h	Copy Permitted, 2 Audio with pre-emphasis
04h	Copy Prohibited, Digital Data
05h	Copy Prohibited, RESERVED
06h	Copy Permitted, Digital Data
07h	Copy Permitted, RESERVED
08h - 0Fh	Broadcast use

10.8.19.2 Example Read TOC Operations

The following example is based on a 4-session, 12-track PhotoCD disc. Data structure is shown as the data to Host.

Command Packet: 43h 00 00 00 00 00 00 10h 00 80h 00 00

Table 134 - Example Read TOC Operations

Ses	A/C	TNO	Pnt	Min Sec Frame	Zero	PMin PSec PFrame	Comments
01	14	00	A0	00 00 00	00	01 20 00	First track is 1. XA disc
01	14	00	A1	00 00 00	00	03 00 00	Last track is 3
01	14	00	A2	00 00 00	00	02 08 3F	Lead Out Area on 1st session
01	14	00	01	00 00 00	00	00 02 00	Start address of track 1
01	14	00	02	00 00 00	00	00 08 02	Start address of track 2
01	14	00	03	00 00 00	00	00 15 32	Start address of track 3
01	54	00	B0	04 26 3F	02	40 02 00	Next recordable area address
01	54	00	C0	C0 00 00	00	61 2C 00	Hybrid disc
02	14	00	A0	00 00 00	00	04 20 00	1st track on 2nd session is 4
02	14	00	A1	00 00 00	00	06 00 00	Last track on 2nd session is 6
02	14	00	A2	00 00 0	00	08 20 08	Lead Out Area on 2nd session
02	14	00	04	00 00 00	00	04 28 3F	Start address of track 4
02	14	00	05	00 00 00	00	04 2E 41	Start address of track 5
02	14	00	06	00 00 00	00	06 27 36	Start address of track 6
02	54	00	B0	09 2C 08	01	40 02 00	Next recordable area address
03	14	00	A0	00 00 00	00	07 20 00	1st track on 3rd session is 7
03	14	00	A1	00 00 00	00	09 00 00	Last track on 3rd session is 9
03	14	00	A2	00 00 00	00	0C 27 32	Lead Out Area on 3rd session
03	14	00	07	00 00 00	00	09 2E 08	Start address of track 7
03	14	00	08	00 00 00	00	09 34 10	Start address of track 8
03	14	00	09	00 00 00	00	0B 04 24	Start address of track 9
03	54	00	B0	20 09 32	01	40 02 00	Next recordable area address
04	14	00	A0	00 00 00	00	0A 20 00	1st track on 4th session is 10
04	14	00	A1	00 00 00	00	0C 00 00	Last track on 4th session is 12
04	14	00	A2	00 00 00	00	12 1B 1A	Lead Out Area on 4th session
04	14	00	0A	00 00 00	00	0E 0B 32	Start address of track 10
04	14	00	0B	00 00 0	00	0E 11 34	Start address of track 11
04	14	00	0C	00 00 00	00	11 08 22	Start address of track 12
04	54	00	B0	13 39 1A	01	40 02 00	Next recordable area address

Ses: session number
A/C: ADR/Control
TNO: 00 for Lead In area
Pnt: POINT

If you use the following command on this disc, Command Packet: 43h 00 00 00 00 00 00h 10h 00 40h 00 00, return data would be:

Table 135 - Values for Control Field in Read TOC

Control Field value	Description
01h	First Session Number
04h	Last Session Number
00h	Reserved
14h	ADR/Control
0Ah (10d)	First Track Number in Last session
00h	Reserved
00h,00h,F8h,EDh (In LBA format, 63725)	Absolute CD-ROM address of first track in last session -> 14M 9S 50F -> add 2 sec: 14M 11S 50F

10.8.20 REQUEST SENSE Command

The REQUEST SENSE command requests that the ATAPI CD-ROM Drive transfer sense data to the Host Computer.

Table 136 - Request Sense Command

Bit Byte	7	6	5	4	3	2	1	0
0	Operation code (03h)							
1	Reserved							
2	Reserved							
3	Reserved							
4	Allocation Length							
5	Reserved							
6	Reserved							
7	Reserved							
8	Reserved							
9	Reserved							
10	Reserved							
11	Reserved							

The sense data:

1. **shall** be available if an error condition (CHECK CONDITION) had previously been reported to the Host Computer;
2. **shall** be available if other information (e.g. medium position) is available in any field.

If the ATAPI CD-ROM Drive has no other sense data available to return, it **shall** return a sense key of NO SENSE and an additional sense code of NO ADDITIONAL SENSE INFORMATION.

The sense data **shall** be preserved by the ATAPI CD-ROM Drive until retrieved by a REQUEST SENSE command or until the receipt of any other I/O Command.

The ATAPI CD-ROM Drive **shall** return CHECK CONDITION status for a REQUEST SENSE command only to report exception conditions specific to the command itself. For example:

1. An ATAPI CD-ROM Drive malfunction prevents return of the sense data.

If a recovered error occurs during the execution of the REQUEST SENSE command, the ATAPI CD-ROM Drive **shall** return the sense data with GOOD status. If an ATAPI CD-ROM Drive returns CHECK CONDITION status for a REQUEST SENSE command, the sense data may be invalid.

ATAPI CD-ROM Drives **shall** be capable of returning at least 18 bytes of data in response to a REQUEST SENSE command. If the allocation length is 18 or greater, and an ATAPI CD-ROM Drive returns less than 18 bytes of data, the Host Computer should assume that the bytes not transferred would have been zeros had the ATAPI CD-ROM Drive returned those bytes. Host Computers can determine how much sense data has been returned by examining the allocation length parameter in the Command Packet and the additional sense length in the sense data. ATAPI CD-ROM Drives **shall** not adjust the additional sense length to reflect truncation if the allocation length is less than the sense data available.

The sense data format for error codes 70h (current errors) and 71h (deferred errors) are defined in "Table 137 - Request Sense Standard Data" on page 180. Error code values of 72h to 7Eh are reserved. Error code 7Fh is for a vendor-specific

sense data format. ATAPI CD-ROM Drives *shall* implement error code 70h; implementation of error code 71h is optional. Error code values of 00h to 6Fh are not defined by this Specification and their use is not recommended.

Table 137 - Request Sense Standard Data

Bit Byte	7	6	5	4	3	2	1	0
0	Valid	Error Code (70h or 71h)						
1	Segment Number (Reserved)							
2	Reserved	ILI	Reserved	Sense Key				
3	Information							
6								
7	Additional Sense Length (n - 7)							
8	Command Specific Information							
11								
12								
13	Additional Sense Code Qualifier (Optional)							
14	Field Replaceable Unit Code (Optional)							
15	SKSV (Optional)	Sense Key Specific (Optional)						
17	Additional Sense Bytes							
18								
n								

A Valid bit of zero indicates that the information field is not as defined in this Specification. A Valid bit of one indicates the information field contains valid information as defined in this Specification. ATAPI CD-ROM Drives *shall* implement the Valid bit.

The Segment Number field is Reserved.

An Incorrect Length Indicator (ILI) bit of one indicates that the requested allocation length did not match the logical block length of the data on the medium.

The Sense Key, Additional Sense Code and Additional Sense Code Qualifier provide a hierarchy of information. The intention of the hierarchy is to provide a top-down approach for a Host Computer to determine information relating to the error and exception conditions. The Sense Key provides generic categories in which error and exception conditions can be reported. Host Computers would typically use sense keys for high-level error recovery procedures. Additional Sense Codes provide further detail describing the sense key. Additional Sense Code Qualifiers add further detail to the additional sense code. The Additional Sense Code and Additional Sense Code Qualifier can be used by Host Computers where sophisticated error recovery procedures require detailed information describing the error and exception conditions.

The Sense Key field is mandatory and indicates generic information describing an error or exception condition. The sense keys are defined in section *Table 140 - "Sense Key Descriptions"*, on page 183.

The contents of the Information field is command-specific and is defined within the appropriate section for the command of interest. ATAPI CD-ROM Drives *shall* implement the Information field. Unless specified otherwise, this field contains the unsigned logical block address associated with the sense key.

The Additional Sense Length field indicates the number of additional sense bytes to follow. If the allocation length of the Command Packet is too small to transfer all of the additional sense bytes, the Additional Sense Length is not adjusted to reflect the truncation.

The Command-specific Information field contains information that depends on the command that was executed. Further meaning for this field is defined within the command description.

The Additional Sense Code (ASC) field indicates further information related to the error or exception condition reported in the Sense Key field. ATAPI CD-ROM Drives *shall* support the Additional Sense Code field. Support of the additional sense codes not explicitly required by this Specification is optional. A list of additional sense codes is in "Table 141 - ASC and ASCQ Assignments" on page 184. If the ATAPI CD-ROM Drive does not have further information related to the error or exception condition, the Additional Sense Code is set to NO ADDITIONAL SENSE INFORMATION.

The Additional Sense Code Qualifier (ASCQ) indicates detailed information related to the Additional Sense Code. The ASCQ is optional. If the error or exception condition is reportable by the device, the value returned *shall* be as specified in "Table 141 - ASC and ASCQ Assignments" on page 184. If the ATAPI CD-ROM Drive does not have detailed information related to the error or exception condition, the ASCQ is set to zero.

Non-zero values in the Field Replaceable Unit Code field are used to define a device-specific mechanism or unit that has failed. A value of zero in this field *shall* indicate that no specific mechanism or unit has been identified to have failed or that the data is not available. The Field Replaceable Unit Code field is optional. The format of this information is not specified by this Specification. Additional information about the field replaceable unit may be available in the ASCII information page, if supported by the ATAPI CD-ROM Drive.

The Additional Sense Bytes field may contain command specific data, peripheral device specific data, or vendor-specific data that further defines the nature of the CHECK CONDITION status.

10.8.20.1 Sense-key Specific

The Sense-key Specific field is defined by this Specification when the value of the Sense-key Specific Valid (SKSV) bit is one. The Sense-key Specific Valid bit and Sense-key Specific field are optional. The definition of this field is determined by the value of the sense key field. This field is reserved for sense keys not described below. An SKSV value of zero indicates that this field is not as defined by this Specification.

If the Sense Key field is set to ILLEGAL REQUEST and the SKSV bit is set to one, the Sense-key Specific field indicates which illegal parameters in the Command Packet or the data parameters are in error.

Table 138 - Field Pointer Bytes

Bit Byte	7	6	5	4	3	2	1	0	
15	SKSV	C/D	Reserved	Reserved	BPV	Bit Pointer			
16	MSB		Field Pointer						
17								LSB	

A Command Data (C/D) bit of one indicates that the illegal parameter is in the Command Packet. A C/D bit of zero indicates that the illegal parameter is in the data parameters sent by the Host Computer.

A Bit Pointer Valid (BPV) bit of zero indicates that the value in the Bit Pointer field is not valid. A BPV bit of one indicates that the Bit Pointer field specifies which bit of the byte designated by the field pointer field is in error. When a multiple-bit field is in error, the Bit Pointer field *shall* point to the most-significant (left-most) bit of the field.

The Field Pointer field indicates which byte of the Command Packet or of the parameter data was in error. Bytes are numbered starting from zero, as shown in the tables describing the commands and parameters. When a multiple-byte field is in error, the pointer *shall* point to the most significant (left-most) byte of the field.

If the sense key is RECOVERED ERROR, HARDWARE ERROR or MEDIUM ERROR and if the SKSV bit is one, the sense-key specific field *shall* be as shown in "Table 139 - Field Pointer Bytes" on page 182.

Table 139 - Field Pointer Bytes

Bit Byte	7	6	5	4	3	2	1	0
15	SKSV	C/D	Reserved	Reserved	BPV	Bit Pointer		
16	MSB		Actual Retry Count				LSB	
17								LSB

The Actual Retry Count field returns implementation-specific information on the actual number of retries of the recovery algorithm used in attempting to recover an error or exception condition. This field should relate to the retry count fields within the Error Recovery Page of the MODE SELECT command.

10.8.20.2 Deferred Errors

Error code 70h indicates that the CHECK CONDITION status returned is the result of an error or exception condition on the I/O process that returned the CHECK CONDITION status. This includes errors generated during execution of the command by the actual execution process. It also includes errors not related to any command that are first observed during execution of a command. Examples of this latter type of error include disk servo-mechanism, off-track errors, and power-up test errors.

Error code 71h (deferred error) indicates that the CHECK CONDITION status returned is the result of an error or exception condition that occurred during execution of a previous command for which GOOD status has already been returned. Such commands are associated with use of the immediate bit, with some forms of caching, and with multiple command buffering. ATAPI CD-ROM Drives that implement these features are required to implement deferred error reporting.

The deferred error may be indicated by returning CHECK CONDITION status to the Host Computer as described below. The subsequent execution of a REQUEST SENSE command *shall* return the deferred error sense information.

If an I/O Command terminates with CHECK CONDITION status and the subsequent sense data returns a deferred error, that I/O command *shall not* have been executed. After the ATAPI CD-ROM Drive detects a deferred error condition on a Device, it *shall* return a deferred error according to the rules described below:

1. If a deferred error can be recovered with no external system intervention, a deferred error indication *shall* not be posted unless required by the error handling parameters of the MODE SELECT command. The occurrence of the error may be logged if statistical or error logging is supported.
2. If a deferred error can be associated with a particular function or a particular subset of data, and the error is either unrecovered or required to be reported by the mode parameters, a deferred error indication *shall* be returned to the Host Computer.

Deferred errors may indicate that an operation was unsuccessful long after the command performing the data transfer returned GOOD status. If data that cannot be replicated or recovered from other sources is being stored using buffered write operations, synchronization commands should be performed before the critical data is destroyed in the host Host Computer. This is necessary to be sure that recovery actions can be taken if deferred errors do occur in the storing of the data.

10.8.20.3 Sense-key and Sense Code Definitions

Table 140 - Sense Key Descriptions

Sense key	Description
0h	NO SENSE. Indicates that there is no specific sense key information to be reported. This would be the case for a successful command.
1h	RECOVERED ERROR. Indicates that the last command completed successfully with some recovery action performed by the ATAPI CD-ROM Drive. Details may be determinable by examining the additional sense bytes and the information field. When multiple recovered errors occur during one command, the choice of which error to report (first, last, most severe, etc.) is device specific.
2h	NOT READY. Indicates that the Device cannot be accessed. Operator intervention may be required to correct this condition.
3h	MEDIUM ERROR. Indicates that the command terminated with a non-recovered error condition that was probably caused by a flaw in the medium or an error in the recorded data. This sense key may also be returned if the ATAPI CD-ROM Drive is unable to distinguish between a flaw in the medium and a specific hardware failure (sense key 4h).
4h	HARDWARE ERROR. Indicates that the ATAPI CD-ROM Drive detected a non-recoverable hardware failure (for example, controller failure, device failure, parity error, etc.) while performing the command or during a self test.
5h	ILLEGAL REQUEST. Indicates that there was an illegal parameter in the Command Packet or in the additional parameters supplied as data for some commands. If the ATAPI CD-ROM Drive detects an invalid parameter in the Command Packet, then it <i>shall</i> terminate the command without altering the medium. If the ATAPI CD-ROM Drive detects an invalid parameter in the additional parameters supplied as data, then the ATAPI CD-ROM Drive may have already altered the medium.
6h	UNIT ATTENTION. Indicates that the removable medium may have been changed or the ATAPI CD-ROM Drive has been reset.
7h	DATA PROTECT. Indicates that a command that reads the medium was attempted on a block that is protected from this operation. The read operation is not performed.
8h	Reserved
9h - Ah	Reserved
Bh	ABORTED COMMAND. Indicates that the device has aborted the command. The Host may be able to recover by trying the command again. This error is reported for conditions such as an overrun etc.
Eh	MISCOMPARE. Indicates that the source data did not match the data read from the medium.
Fh	Reserved

10.8.20.4 Using the REQUEST SENSE Command

Whenever an Error is reported, the Host Computer should issue a REQUEST SENSE command to receive the sense data describing what caused the Error condition. If the Host Computer issues some other command, the sense data is lost.

		D - DIRECT ACCESS DEVICE	
		R - READ ONLY (CD-ROM) DEVICE	
		O - OPTICAL MEMORY DEVICE	
		M - MEDIA CHANGER DEVICE	
ASC	ASCQ	DROM	DESCRIPTION
00	00	DROM	NO ADDITIONAL SENSE INFORMATION
00	11	R	PLAY OPERATION IN PROGRESS
00	12	R	PLAY OPERATION PAUSED
00	13	R	PLAY OPERATION SUCCESSFULLY COMPLETED
00	14	R	PLAY OPERATION STOPPED DUE TO ERROR
00	15	R	NO CURRENT AUDIO STATUS TO RETURN
01	00	R	MECHANICAL POSITIONING OR CHANGER ERROR
02	00	DROM	NO SEEK COMPLETE
04	00	DROM	LOGICAL DRIVE NOT READY - CAUSE NOT REPORTABLE
04	01	DROM	LOGICAL DRIVE NOT READY - IN PROGRESS OF BECOMING READY
04	02	DROM	LOGICAL DRIVE NOT READY - INITIALIZING COMMAND REQUIRED
04	03	DROM	LOGICAL DRIVE NOT READY - MANUAL INTERVENTION REQUIRED
05	01	DROM	MEDIA LOAD - EJECT FAILED
06	00	DROM	NO REFERENCE POSITION FOUND
09	00	DRO	TRACK FOLLOWING ERROR
09	01	RO	TRACKING SERVO FAILURE
09	02	RO	FOCUS SERVO FAILURE
09	03	RO	SPINDLE SERVO FAILURE
11	00	DRO	UNRECOVERED READ ERROR
11	06	RO	CIRC UNRECOVERED ERROR
15	00	DROM	RANDOM POSITIONING ERROR
15	01	DROM	MECHANICAL POSITIONING OR CHANGER ERROR
15	02	DRO	POSITIONING ERROR DETECTED BY READ OF MEDIUM
17	00	DRO	RECOVERED DATA WITH NO ERROR CORRECTION APPLIED
17	01	DRO	RECOVERED DATA WITH RETRIES
17	02	DRO	RECOVERED DATA WITH POSITIVE HEAD OFFSET
17	03	DRO	RECOVERED DATA WITH NEGATIVE HEAD OFFSET
17	04	RO	RECOVERED DATA WITH RETRIES AND/OR CIRC APPLIED
17	05	DRO	RECOVERED DATA USING PREVIOUS SECTOR ID
18	00	DRO	RECOVERED DATA WITH ERROR CORRECTION APPLIED
18	01	DRO	RECOVERED DATA WITH ERROR CORRECTION & RETRIES APPLIED
18	02	DRO	RECOVERED DATA - THE DATA WAS AUTO-REALLOCATED
18	03	R	RECOVERED DATA WITH CIRC
18	04	R	RECOVERED DATA WITH L-EC
1A	00	DROM	PARAMETER LIST LENGTH ERROR
20	00	DROM	INVALID COMMAND OPERATION CODE
21	00	DROM	LOGICAL BLOCK ADDRESS OUT OF RANGE
24	00	DROM	INVALID FIELD IN COMMAND PACKET
26	00	DROM	INVALID FIELD IN PARAMETER LIST
26	01	DROM	PARAMETER NOT SUPPORTED
26	02	DROM	PARAMETER VALUE INVALID

Table 141 - ASC and ASCQ Assignments

ASC	ASCQ	DROM	DESCRIPTION
28	00	DROM	NOT READY TO READY TRANSITION, MEDIUM MAY HAVE CHANGED
29	00	DROM	POWER ON, RESET OR BUS DEVICE RESET OCCURRED
2A	00	DROM	PARAMETERS CHANGED
2A	01	DROM	MODE PARAMETERS CHANGED
30	00	DROM	INCOMPATIBLE MEDIUM INSTALLED
30	01	DRO	CANNOT READ MEDIUM - UNKNOWN FORMAT
30	02	DRO	CANNOT READ MEDIUM - INCOMPATIBLE FORMAT
39	00	DROM	SAVING PARAMETERS NOT SUPPORTED
3A	00	DROM	MEDIUM NOT PRESENT
3F	00	DROM	ATAPI CD-ROM DRIVE OPERATING CONDITIONS HAVE CHANGED
3F	01	DROM	MICROCODE HAS BEEN CHANGED
40	NN	DROM	DIAGNOSTIC FAILURE ON COMPONENT NN (80H-FFH)
44	00	DROM	INTERNAL ATAPI CD-ROM DRIVE FAILURE
4E	00	DROM	OVERLAPPED COMMANDS ATTEMPTED
53	00	DROM	MEDIA LOAD OR EJECT FAILED
53	02	DROM	MEDIUM REMOVAL PREVENTED
57	00	R	UNABLE TO RECOVER TABLE OF CONTENTS
5A	00	DROM	OPERATOR REQUEST OR STATE CHANGE INPUT (UNSPECIFIED)
5A	01	DROM	OPERATOR MEDIUM REMOVAL REQUEST
63	00	R	END OF USER AREA ENCOUNTERED ON THIS TRACK
64	00	R	ILLEGAL MODE FOR THIS TRACK
B9	00	R	PLAY OPERATION OBORTED
BF	00	R	LOSS OF STREAMING
80h XXh THROUGH FFh XX			Vendor-specific.
XXh 80h THROUGH XXh DDh			Vendor-specific QUALIFICATION OF STANDARD ASC.
ALL CODES NOT SHOWN ARE RESERVED.			

Table 141 - ASC and ASCQ Assignments

Table 142 - Recommended Sense Key, ASC and ASCQ for Request Sense Command Errors

Sense Key	ASC	ASCQ	Description of Error
05	20		INVALID COMMAND OPERATION CODE
05	24		INVALID FIELD IN COMMAND PACKET
06	28		NOT READY TO READY TRANSITION
06	29		POWER ON, RESET OR BUS DEVICE RESET OCCURRED

Intentionally Left Blank

10.8.21 SCAN Command

The SCAN command requests a fast-forward or fast-reverse scan operation starting from the Scan Starting Address. The command *shall* scan all the way to the end of the media (last audio track).

This command responds with immediate status, allowing overlapped commands. This command *shall* set the DSC bit upon command completion. See also "10.4 Immediate Command Processing Considerations" on page 90.

A Direction (DIRECT) bit of zero indicates a fast-forward. A DIRECT bit of one indicates a fast-reversed operation.

The Scan Starting Address specifies the address at which the Audio Fast Scan *shall* begin. The Type Field determines the interpretation of the address.

Like the Audio Play Command, the SCAN Command *shall* terminate the scan at the last audio track or upon receipt of the STOP PLAY / SCAN Command. Upon receipt of the STOP PLAY / SCAN Command the Device *shall* set the current address to the last address output during the SCAN Command. Subsequent Audio Play Commands *shall* cause the device to begin playing at the location last output by the SCAN Command. If the drive receives a PAUSE/RESUME Command with the resume bit clear, the drive shall pause. After that, if the drive receives a PAUSE/RESUME Command with the resume bit set, the drive shall resume audio play (note: not scan) from the address where the audio pause occurred. See "Figure 15 - Stop Play/Play Audio/Audio Scan/Pause/Resume Sequencing" on page 196 for additional information.

If the drive receives a SCAN Command during play or pause, the drive shall stop play or pause and perform Scan.

Upon receipt of a READ SUB-CHANNEL Command during scan, the drive shall return an Audio Status of 11h (Audio Play operation in Progress).

If the drive receives a SCAN Command during play or pause for which a valid stop address was specified, the drive will remember the stop address but ignore it during the scan command. The stop address becomes valid again when audio play resumes. Thus, upon resumption of audio play, if the current address is greater than the former stop address, the drive shall stop playing and return good status. After this, if the drive receives a READ SUB-CHANNEL Command, the drive shall return an Audio Status of 13h (Audio Play operation successfully completed).

If the drive reaches a data track, it shall stop scan.

Request to the implementer: *The following implementation of forward and reverse scan speed will provide good quality sound: Forward scan - [Play six CD-DA blocks and then jump 190* CD-DA blocks in the forward direction. Reverse scan - play six CD-DA blocks and then jump 150* CD-DA blocks (from the last block of the six) in the reverse direction.*

*This can be some fixed number between 150 and 200..

Table 143 - SCAN Command

Bit Byte	7	6	5	4	3	2	1	0
0	Operation code (BAh)							
1	Reserved			DIRECT	Reserved			
2	MSB Scan Starting Address Field LSB							
3								
4								
5								
6	Reserved							
7	Reserved							
8								
9	Type			Reserved				
10	Reserved							
11	Reserved							

Bits 7-6	Type	This field specifies the "Type" of address contained in the Scan Starting Address Field.
0	0	Logical Block Address format
0	1	AMIN, ASEC and AFRAME format
1	0	Track Number (TNO) format
1	1	Reserved

See "10.8.8.1 Play Audio with Immediate Packet Commands" on page 126 for information on overlapped commands during a SCAN operation.

Table 144 - Scan Starting Address in Logical Block Format

Bit Byte	7	6	5	4	3	2	1	0	
2	Scan Starting Address Field							LSB	
3									
4									
5									

Table 145 - Scan Starting Address in AMIN, ASEC and AFRAME Format

Bit Byte	7	6	5	4	3	2	1	0
2	Reserved							
3	CD-absolute time (AMIN)							
4	CD-absolute time (ASEC)							
5	CD-absolute time (AFRAME)							

The AMIN, ASEC and AFRAME fields specifies the relative running time from the beginning of the disc. The AMIN field has a range of 00 to 99d (63h). The ASEC ranges from 00 to 59d (3Bh). The AFRAME field has a range of 00 to 74d (4Ah). All MSF fields *shall* be Binary.

Table 146 - Scan Starting Address in Track Number (TNO) Format

Bit Byte	7	6	5	4	3	2	1	0
2	Reserved							
3	Reserved							
4	Reserved							
5	Track Number (TNO)							

The Track Number field specifies the track in binary notation at which the scan operation will begin. This field has a range of 01h to 63h.

Table 147 - Recommended Sense Key, ASC and ASCQ for Scan Command Errors

Sense Key	ASC	ASCQ	Description of Error
05	20		INVALID COMMAND OPERATION CODE
05	24		INVALID FIELD IN COMMAND PACKET
06	28		NOT READY TO READY TRANSITION
06	29		POWER ON, RESET OR BUS DEVICE RESET OCCURRED
02	04	00	LOGICAL DRIVE NOT READY - CAUSE NOT REPORTABLE
02	04	01	LOGICAL DRIVE NOT READY - IN PROGRESS OF BECOMING READY
02	04	02	LOGICAL DRIVE NOT READY - INITIALIZING COMMAND REQUIRED
02	04	03	LOGICAL DRIVE NOT READY - MANUAL INTERVENTION REQUIRED
02	3A		MEDIUM NOT PRESENT
03	02		NO SEEK COMPLETE
02	06	00	NO REFERENCE POSITION FOUND (media may be upside down)
02	30	00	INCOMPATIBLE MEDIUM INSTALLED
02	30	01	CANNOT READ MEDIUM - UNKNOWN FORMAT
02	30	02	CANNOT READ MEDIUM - INCOMPATIBLE FORMAT
05	21		LOGICAL BLOCK ADDRESS OUT OF RANGE
05	64		ILLEGAL MODE FOR THIS TRACK OR INCOMPATIBLE MEDIUM

When a Play CD command is actively using one of the Digital Output ports a Scan command shall be aborted with error (05/64) ILLEGAL MODE FOR THIS TRACK.

Intentionally Left Blank

10.8.22 SEEK Command

The SEEK command request that the Device seek to the specified logical block address. All Logical Block Addresses are valid targets for a seek operation, including a CD-DA audio sector. The content of the Sector at the specified LBA *shall not* affect the seek operation nor cause an error to be generated.

The SEEK Command will always be executed as an immediate command. The command will return completion stations as soon as the seek operation has been started.

Table 148 - SEEK Command

Bit Byte	7	6	5	4	3	2	1	0
0	Operation code (2Bh)							
1	Reserved							
2	MSB Logical Block Address							
3								
4								
5								
6	Reserved							
7	Reserved							
8	Reserved							
9	Reserved							
10	Reserved							
11	Reserved							

Table 149 - Recommended Sense Key, ASC and ASCQ for Seek Command Errors

Sense Key	ASC	ASCQ	Description of Error
05	20		INVALID COMMAND OPERATION CODE
05	24		INVALID FIELD IN COMMAND PACKET
06	28		NOT READY TO READY TRANSITION
06	29		POWER ON, RESET OR BUS DEVICE RESET OCCURRED
02	04	00	LOGICAL DRIVE NOT READY - CAUSE NOT REPORTABLE
02	04	01	LOGICAL DRIVE NOT READY - IN PROGRESS OF BECOMING READY
02	04	02	LOGICAL DRIVE NOT READY - INITIALIZING COMMAND REQUIRED
02	04	03	LOGICAL DRIVE NOT READY - MANUAL INTERVENTION REQUIRED
02	06	00	NO REFERENCE POSITION FOUND (media may be upside down)
02	3A		MEDIUM NOT PRESENT
03	02		NO SEEK COMPLETE
05	21		LOGICAL BLOCK ADDRESS OUT OF RANGE

Intentionally Left Blank

10.8.23 SET CD SPEED Command

The SET CD SPEED command provides a means for the Host to set the spindle speed to be used while reading and writing CD data. Note that the Play commands may not use the speed set by this command.

Table 150 - SET CD-ROM SPEED Command

Bit Byte	7	6	5	4	3	2	1	0		
0	Operation code (BBh)									
1	Reserved									
2	MSB		Read Drive Speed in Kbytes/Second						LSB	
3										
4	MSB		Reserved for Write Drive Speed in Kbytes/Second						LSB	
5										
6	Reserved									
7	Reserved									
8	Reserved									
9	Reserved									
10	Reserved									
11	Reserved									

The Drive Speed parameter contains the requested Data Rate the drive should use. The drive may choose to select the speed specified or any slower rate. A value of FFFFh will set the Drive Speed to the Maximum supported. Requesting a speed faster than the drive supports will not generate an error. The actual maximum speed supported is returned in the Capabilities Mode Sense page (See "10.8.6.4 CD-ROM Capabilities and Mechanical Status Page" on page 118.)

If the speed selected is less than 1x, then the drive *shall* reject the command, and not change the speed.

Table 151 - Recommended Sense Key, ASC and ASCQ for SET CD SPEED Command Errors

Sense Key	ASC	ASCQ	Description of Error
05	20		INVALID COMMAND OPERATION CODE
05	24		INVALID FIELD IN COMMAND PACKET
06	28		NOT READY TO READY TRANSITION
06	29		POWER ON, RESET OR BUS DEVICE RESET OCCURRED
02	04	00	LOGICAL DRIVE NOT READY - CAUSE NOT REPORTABLE
02	04	01	LOGICAL DRIVE NOT READY - IN PROGRESS OF BECOMING READY
02	04	02	LOGICAL DRIVE NOT READY - INITIALIZING COMMAND REQUIRED
02	04	03	LOGICAL DRIVE NOT READY - MANUAL INTERVENTION REQUIRED
02	06	00	NO REFERENCE POSITION FOUND (media may be upside down)
02	3A		MEDIUM NOT PRESENT

Intentionally Left Blank

10.8.24 STOP PLAY / SCAN CD-ROM Command

The STOP PLAY/ SCAN CD-ROM Command stops playback of CD-ROM audio commands.

Table 152 - STOP PLAY / SCAN CD-ROM Command

Bit Byte	7	6	5	4	3	2	1	0
0	Operation code (4Eh)							
1	Reserved							
2	Reserved							
3	Reserved							
4	Reserved							
5	Reserved							
6	Reserved							
7	Reserved							
8	Reserved							
9	Reserved							
10	Reserved							
11	Reserved							

Table 153 - Recommended Sense Key, ASC and ASCQ for STOP PLAY CD-ROM Command Errors

Sense Key	ASC	ASCQ	Description of Error
05	20		INVALID COMMAND OPERATION CODE
05	24		INVALID FIELD IN COMMAND PACKET
06	28		NOT READY TO READY TRANSITION
06	29		POWER ON, RESET OR BUS DEVICE RESET OCCURRED
02	04	00	LOGICAL DRIVE NOT READY - CAUSE NOT REPORTABLE
02	04	01	LOGICAL DRIVE NOT READY - IN PROGRESS OF BECOMING READY
02	04	02	LOGICAL DRIVE NOT READY - INITIALIZING COMMAND REQUIRED
02	04	03	LOGICAL DRIVE NOT READY - MANUAL INTERVENTION REQUIRED
02	05		MEDIA LOAD OR EJECT FAILED
02	06	00	NO REFERENCE POSITION FOUND (media may be upside down)
02	3A		MEDIUM NOT PRESENT

Issuing a Stop Play / Scan command while the drive is scanning *shall* result in continuation of the play command. Issuing a Stop Play / Scan command while the drive is paused *shall* stop the play command

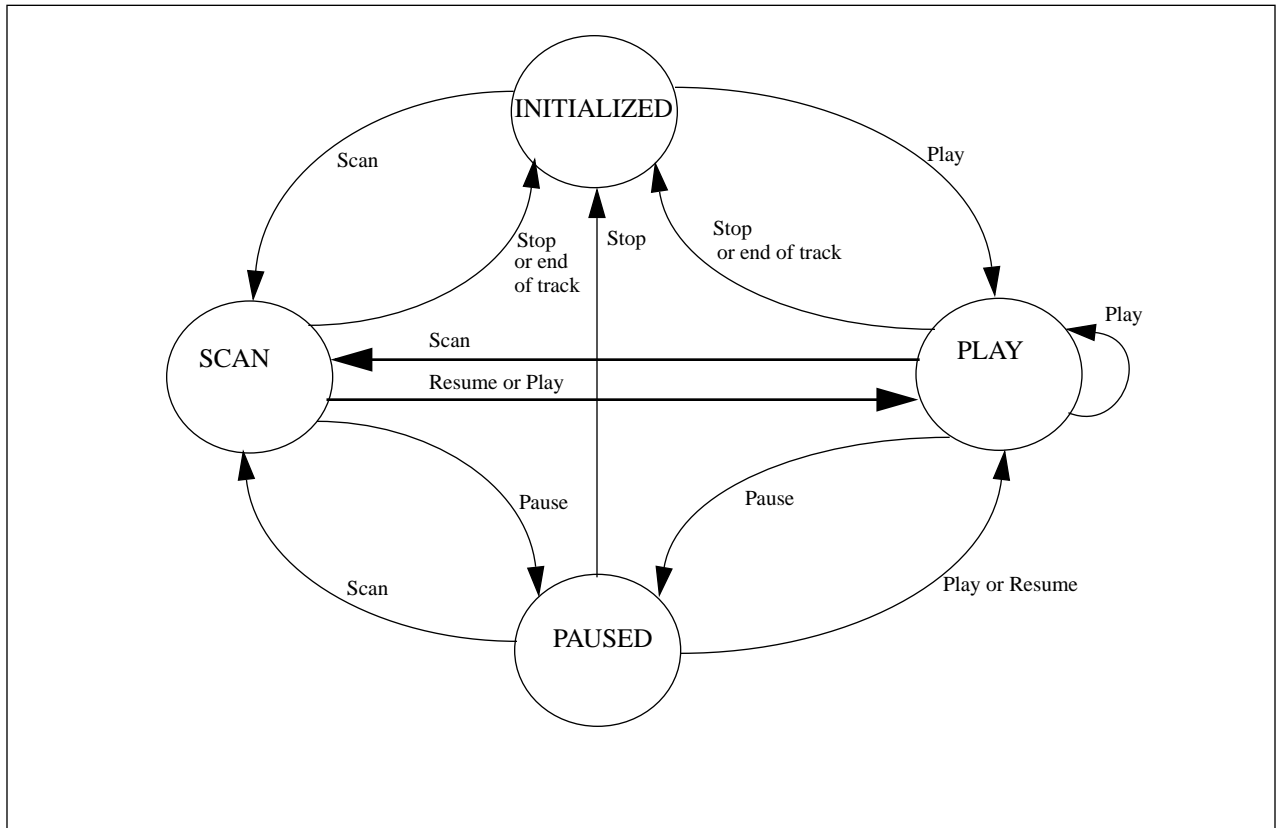

Figure 15 - Stop Play/Play Audio/Audio Scan/Pause/Resume Sequencing

10.8.25 START/STOP UNIT Command

The START/STOP UNIT command requests that the ATAPI CD-ROM Drive enable or disable media access operations.

Table 154 - START/STOP UNIT Command

Bit Byte	7	6	5	4	3	2	1	0
0	Operation code (1Bh)							
1	Reserved							Immed
2	Reserved							
3	Reserved							
4	Reserved						LoEj	Start
5	Reserved							
6	Reserved							
7	Reserved							
8	Reserved							
9	Reserved							
10	Reserved							
11	Reserved							

An immediate (Immed) bit of one indicates that status *shall* be returned as soon as the Command Packet has been validated. An Immed bit of zero indicates that status *shall* be returned after the operation is completed.

A start bit of one requests the Device be made ready for use. A start bit of zero requests that the Device be stopped (media cannot be accessed by the Host Computer).

Table 155 - Start/Stop and Eject Operations

LoEj	Start	Operation to be Performed
0	0	Stop the Disc
0	1	Start the Disc and read the TOC
1	0	Eject the Disc if possible (See "Table 84 - Actions for Lock / Unlock / Eject" on page 136)
1	1	Load the Disc (Close Tray)

Any attempt to Eject or Load a Disc when the Drive does not support that capability *shall* result in an error condition being reported to the Host (Sense key 05 ILLEGAL REQUEST, Sense Code 24 INVALID FIELD IN COMMAND PACKET.)

A load eject (LoEj) bit of zero requests that no action be taken regarding loading or ejecting the medium. A LoEj bit of one requests that the medium be unloaded if the start bit is zero. A LoEj bit of one requests that the medium be loaded if the start bit is one.

When the Loading Mechanism Type is a Changer utilizing individual disc change capability (4h), the Eject operation *shall* only eject the disc that is currently in the Play Position. If the Loading Mechanism is a changer utilizing a Cartridge (5h), then the Cartridge *shall* only be ejected when no media is in the play position.

Table 156 - Actions for Eject/Load Disc

Operation	Locked / Unlocked	If Drive Not Ready (No Media)	If Drive Ready (Media Present)
Eject	Unlocked	No Error and Tray is opened	No Error: Media Ejects
	Locked	Error: 02 Not ready, 53 Media Removal Prevented	Error: 02 Not ready, 53 Media Removal Prevented
	Changer using Cartridge with Disc in Play Position	Error: 02 Not ready, 53 Media Removal Prevented	Error: 02 Not ready, 53 Media Removal Prevented
	Changer using Individual disc changability with no Disc in the Play Position	Error: 02 Not ready, 53 Media Removal Prevented	Error: 02 Not ready, 53 Media Removal Prevented
Manual Eject	Unlocked	Tray opens (If tray exists)	Media is Ejected
	Locked	No operation occurs	No operation, Media stays locked in drive

Table 157 - Recommended Sense Key, ASC and ASCQ for SEEK Command Errors

Sense Key	ASC	ASCQ	Description of Error
05	20		INVALID COMMAND OPERATION CODE
05	24		INVALID FIELD IN COMMAND PACKET
06	28		NOT READY TO READY TRANSITION
06	29		POWER ON, RESET OR BUS DEVICE RESET OCCURRED
02	04	00	LOGICAL DRIVE NOT READY - CAUSE NOT REPORTABLE
02	04	01	LOGICAL DRIVE NOT READY - IN PROGRESS OF BECOMING READY
02	04	02	LOGICAL DRIVE NOT READY - INITIALIZING COMMAND REQUIRED
02	04	03	LOGICAL DRIVE NOT READY - MANUAL INTERVENTION REQUIRED
02	06	00	NO REFERENCE POSITION FOUND (media may be upside down)
02	3A		MEDIUM NOT PRESENT
02	53	02	MEDIA REMOVAL PREVENTED
04	B6		MEDIA LOAD MECHNISM FAILED

10.8.26 TEST UNIT READY Command

The TEST UNIT READY command provides a means to check if the Device is ready. This is not a request for a self-test. If the Device would accept an appropriate medium-access command without returning CHECK CONDITION status, this command *shall* return a GOOD status. If the Device cannot become operational or is in a state such that an Host Computer action (e.g. START/STOP UNIT command with LoEj = 0 & Start = 1) is required to make the unit ready, the ATAPI CD-ROM Drive *shall* return CHECK CONDITION status with a sense key of NOT READY.

Table 158 - Test Unit Ready Command

Bit Byte	7	6	5	4	3	2	1	0
0	Operation code (00h)							
1	Reserved							
2	Reserved							
3	Reserved							
4	Reserved							
5	Reserved							
6	Reserved							
7	Reserved							
8	Reserved							
9	Reserved							
10	Reserved							
11	Reserved							

10.8.26.1 Using the TEST UNIT READY Command

The TEST UNIT READY command is useful in that it allows a Host Computer to poll a Device until it is ready without the need to allocate space for returned data. It is especially useful to check cartridge status. ATAPI CD-ROM Drives are expected to respond promptly to indicate the current status of the device.

Table 159 - Recommended Sense Key, ASC and ASCQ for MODE SELECT Command Errors

Sense Key	ASC	ASCQ	Description of Error
00	00	00	NO ADDITIONAL SENSE INFORMATION
05	20		INVALID COMMAND OPERATION CODE
05	24		INVALID FIELD IN COMMAND PACKET
02	04	00	LOGICAL DRIVE NOT READY - CAUSE NOT REPORTABLE
02	04	01	LOGICAL DRIVE NOT READY - IN PROGRESS OF BECOMING READY
02	04	02	LOGICAL DRIVE NOT READY - INITIALIZING COMMAND REQUIRED
02	04	03	LOGICAL DRIVE NOT READY - MANUAL INTERVENTION REQUIRED
02	06	00	NO REFERENCE POSITION FOUND (media may be upside down)
02	30	00	INCOMPATIBLE MEDIUM INSTALLED
02	30	01	CANNOT READ MEDIUM - UNKNOWN FORMAT
02	30	02	CANNOT READ MEDIUM - INCOMPATIBLE FORMAT
02	3A		MEDIUM NOT PRESENT

Note: Some drives return ASC/ASCQ with audio, status and sense code 00 when there is no error condition.

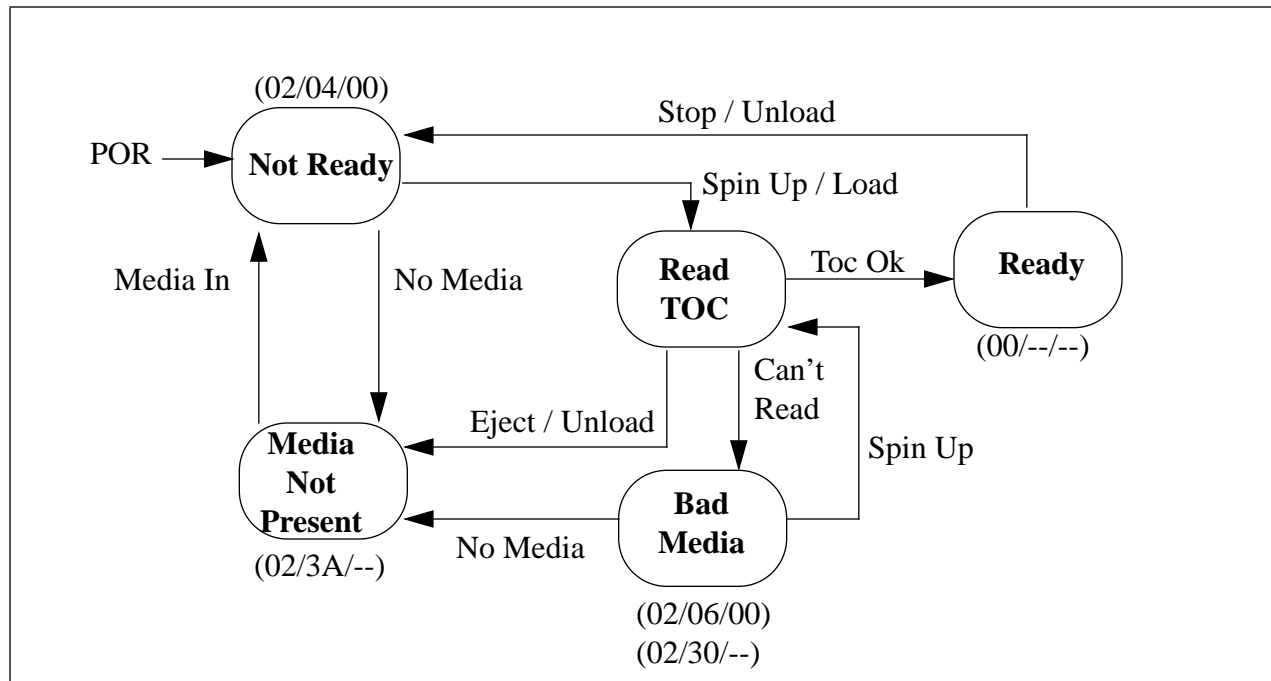

Figure 16 - Test Unit Ready State Diagram

11.0 Physical Interface

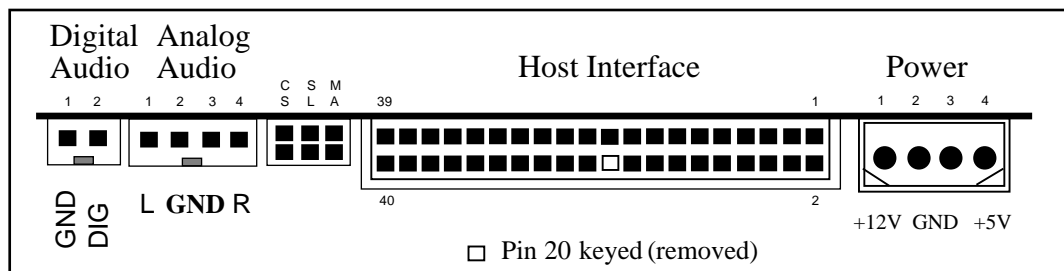
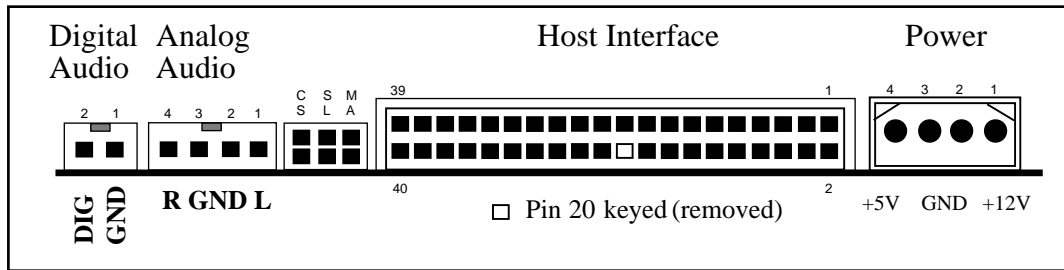

Figure 17 - CD-ROM Connectors (Rear View)

11.1 CD-ROM Digital Audio Connector (Optional)

The CD-ROM Digital Audio Connector is an optional two-conductor shroud keyed header (Molex 70553 “G” or equivalent) which can be used to send audio to the host in a digital serial format. The pin assignments are shown in "Figure 17 - CD-ROM Connectors (Rear View)". The logic levels on this connector are standard CMOS and *shall* not exceed +5% of the 5v supply. Recommended part numbers for the mating connector to 18 AWG cable are shown, but equivalent parts may be used.

Mating Connectors: Molex 70066 “C(No Latch)” or “G(Latch)”, 70400 “C” or “G” and 70430 “C” or “G” or equivalent.

The serial format of the audio data is defined in EIAJ (Electronic Industry Association of Japan) document IEC-958. IEC-958 has two parts. One is for professional use that is similar to the AES/EBU(Audio Engineering Society / European Broadcast Union). The other part is for consumer use and is the same as the Sony/Philips Digital Signal format. When referring to EIAJ, specify which part is supported.

11.2 CD-ROM Analog Audio Connector (Optional)

The CD-ROM Analog Audio Connector is an optional four-conductor shroud keyed header (Molex 70553 “G” or equivalent) which can be used to send audio to the host in an analog format. The pin assignments are shown in "Figure 17 - CD-ROM Connectors (Rear View)". The analog voltage levels on this connector *shall not* exceed 1.0V RMS. Recommended part numbers for the mating connector to 18 AWG cable are shown, but equivalent parts may be used.

Mating Connectors: Molex 70066 “C(No Latch)” or “G(Latch)”, 70400 “C” or “G” and 70430 “C” or “G” or equivalent.

11.3 Device Configuration Jumper (Optional)

The device configuration jumper is a 6-pin, unshrouded header (Molex 70203 or equivalent) as shown in "Figure 17 - CD-ROM Connectors (Rear View)" with three marked positions (CS, SL, and MA). When a shorting jumper is placed in the "CS" (CSEL) position the device *shall* use the "MA" (Master) or "SL" (Slave) jumper positions to configure the device. When the "CS" jumper is removed and placed such that both "SL" and "MA" are jumpered, the device *shall* use the host interface signal CSEL to configure the device. The device configuration jumpers *shall* be accessible from the rear of the drive.

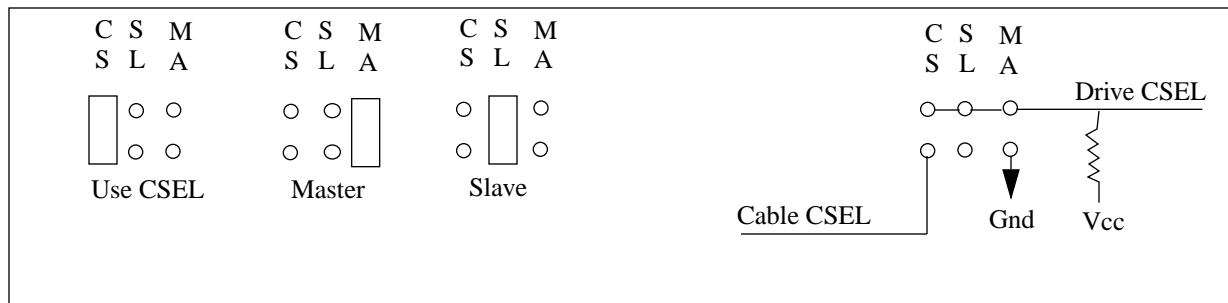

Figure 18 - Device Configuration Jumper

11.4 Host IDE Interface Connector

The I/O connector is a 40-pin connector as shown in Figure 4 (ATA specification), with pin assignments as shown in Table 4 (ATA specification). The connector should be keyed to prevent the possibility of installing it upside down. A key is provided by the removal of pin 20. The corresponding pin on the cable connector should be plugged.

The pin locations are governed by the cable plug, not the receptacle. The way in which the receptacle is mounted on the printed circuit board affects the pin positions, and pin 1 should remain in the same relative position. This means the pin numbers of the receptacle may not reflect the conductor number of the plug. The header receptacle is not polarized, and all the signals are relative to pin 20, which is keyed.

By using the plug positions as primary, a straight cable can connect drives. As shown in Figure 4 (ATA specification, conductor 1 on pin 1 of the plug has to be in the same relative position no matter what the receptacle numbering looks like. If receptacle numbering was followed, the cable would have to twist 180 degrees between a drive with top-mounted receptacles, and a drive with bottom-mounted receptacles.

11.5 Power Connector

The power connector is a four-conductor male plug. The pin assignments are shown in "Figure 17 - CD-ROM Connectors (Rear View)". Recommended part numbers for the mating connector to 28 AWG cable are shown below, but equivalent parts may be used.

- Connector (4-pin): AMP 1-480424-0 or equivalent.
- Contacts (loose piece): AMP 60619-4 or equivalent.
- Contacts (strip): AMP 61117-4 or equivalent.

Annex A Play CD Decoder Types & Formats

The EBU IEC958 Standard shall be used for the Digital Output Port.

Attach IEC958 here.

Intentionally Left Blank

Annex B Connectors

70553 Series

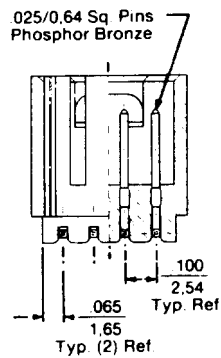
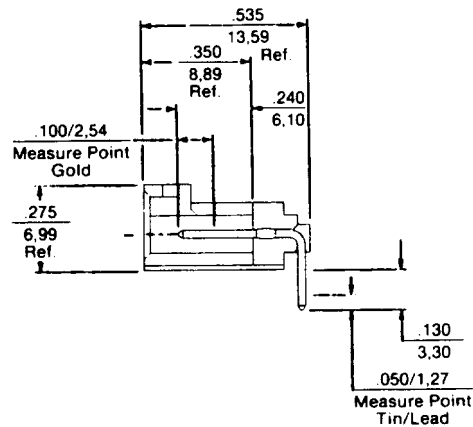
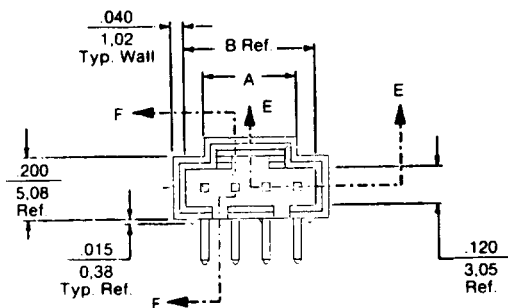
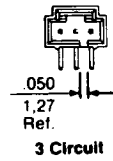
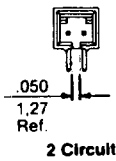
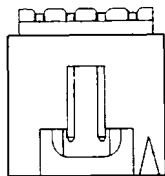
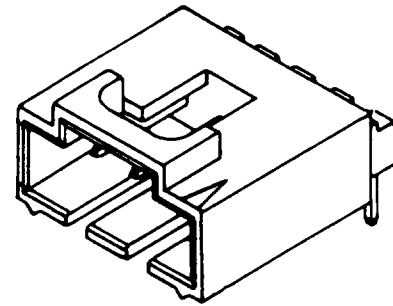

**Recommended P.C. Board
Hole Layout**

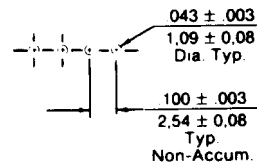

Dimensions

Circuits	Dim. A	Dim. B
2	.100 2,54	.210 5,33
3	.200 5,08	.320 8,13
4	.300 7,62	.420 10,67

70066 Series "C" Version

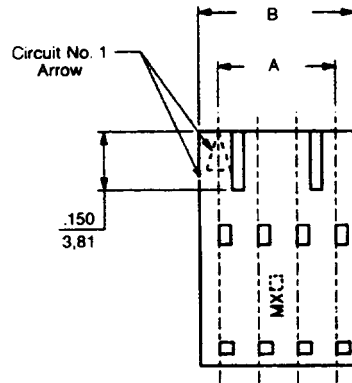
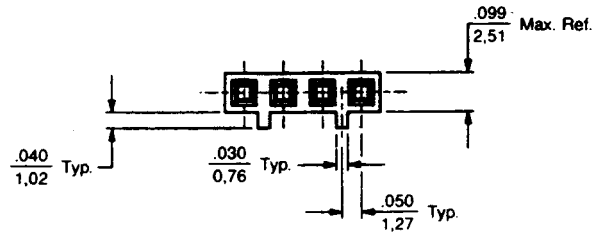
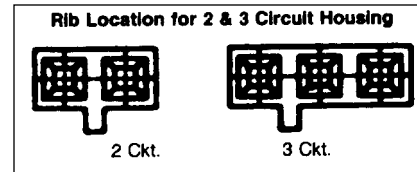
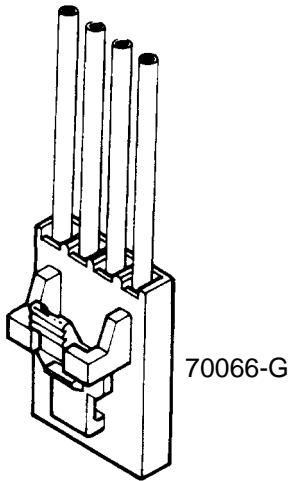
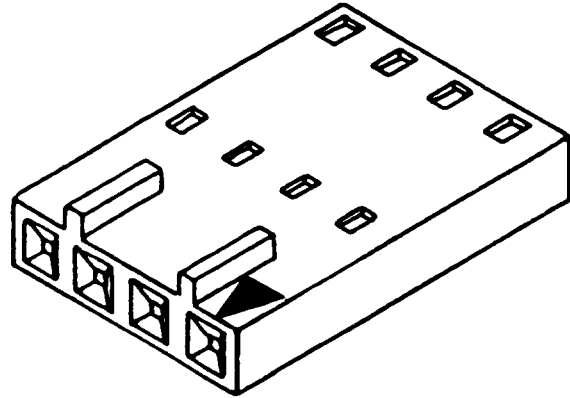

Section C-C

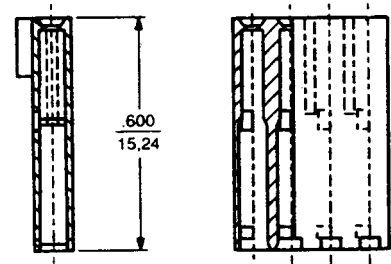

Dimensions

Circuits	Dim. A	Dim. B
2	.100 2,54	.199 5,05
3	.200 5,08	.299 7,59
4	.300 7,62	.399 10,13

70203 Series

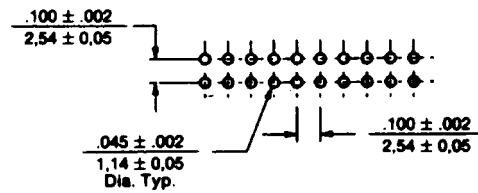
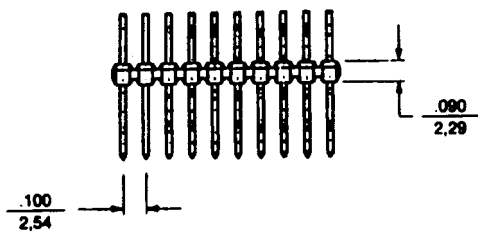
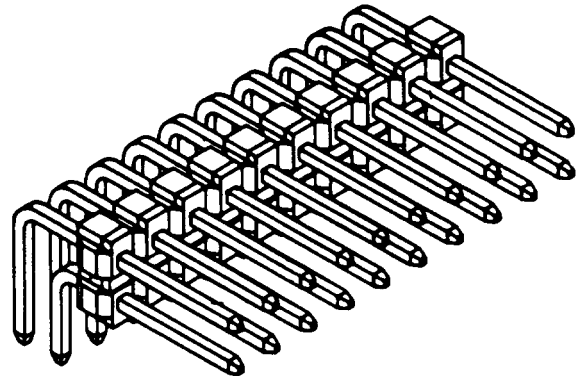

Recommended PC Board Hole Layout

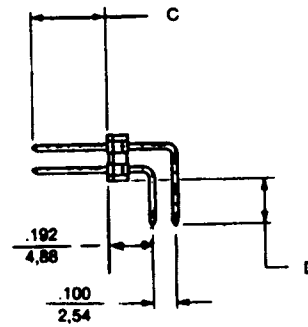
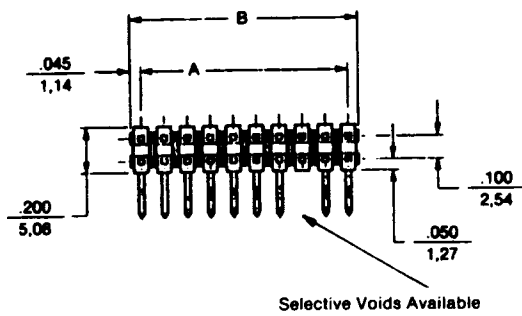

Dimensions

In the Far East, this product has different engineering and order numbers
Contact Factory for sales drawings for 70294-xxx

Circuits	Dim. A	Dim. B
4	.100 2,54	.190 4,83
6	.200 5,08	.290 7,37

For circuit sized 8 through 80 add .100 or 2,54mm for each additional pin position

Intentionally Left Blank

